

Transistors

theory and practice

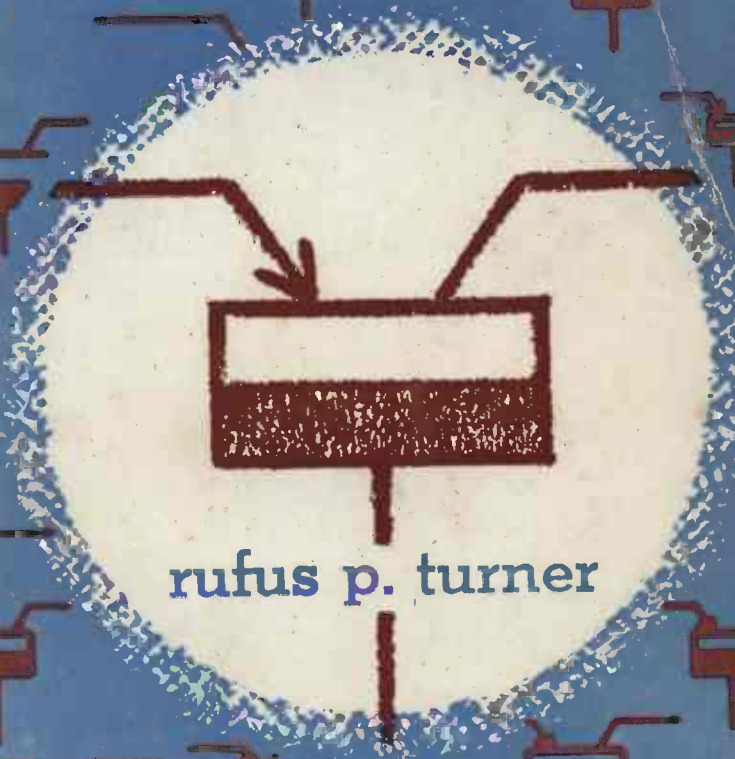

rufus p. turner

No 51 GERNSBACK LIBRARY



\$2.00

TRANSISTORS THEORY and PRACTICE

by

RUFUS P. TURNER

Registered Professional Engineer



Gernsback Library No. 51

PUBLISHED BY
GERNSBACK LIBRARY, INC.
25 West Broadway,
New York 7, N. Y.

TO MARY

25 years indispensable

ABOUT THE AUTHOR

Rufus P. Turner has been active for a number of years in the application of semiconductor devices. His interest in crystal devices dates back to 1922. A veteran radio writer, he is well known for his articles and pamphlets on crystal diodes which appeared with great frequency from 1946 to 1952.

Immediately after the transistor was announced in 1948, Mr. Turner began his experiments with this device, making his own transistors from germanium diodes. His article *Build A Transistor* (RADIO-ELECTRONICS, May 1949) was reprinted in several languages by foreign radio magazines and aroused world-wide enthusiasm. As soon as commercial transistors became available early in 1949, he turned his attention to these devices and soon afterward wrote *A Crystal Receiver with Transistor Amplifier* (RADIO & TELEVISION NEWS, January 1950). This latter article is one of the few on practical applications listed in Dr. William Shockley's book "Electrons and Holes in Semiconductors." Numerous other transistor articles by Turner have appeared in the magazines.

THE PUBLISHERS

COPYRIGHT, 1954

BY HUGO GERNSBACK

All rights reserved under Universal, International, and Pan-American Copyright Conventions

First Printing — April, 1954

Second Printing — June, 1955

Third Printing — November, 1955

Transistors

Preface	4
Chapter 1 . . . Semiconductor Theory	5
Crystals. Semiconductors and their action. Electrons and holes. Germanium. Action of P-N junction. Semiconductor diode. Hole and electron injection.	
Chapter 2 . . . Transistor Characteristics	17
Basic considerations. Transistor types, action, parameters. Single-stage transistor configurations.	
Chapter 3 . . . Equivalent Circuits	41
Equivalent resistance network. Network parameters. Grounded-base, grounded-emitter, grounded-collector amplifiers. Power amplification. Reverse power amplification. Electrode external resistances. Equivalent noise circuit.	
Chapter 4 . . . Transistor Amplifiers	47
Basic circuit features. Single vs. multiple bias supply. Constant current requirement. Low-power operation. Input-output coupling. Cascading amplifier stages. Conventional push-pull operation. Push-pull by complementary symmetry. Push-pull class-B operation. Gain control. Negative feedback. Plot of output characteristics. Direct-coupled amplifier. R.f. amplifiers.	
Chapter 5 . . . Transistor Oscillators	65
Oscillator operation. Base-tuned circuit. Oscillators with tickler feedback. Series-resonant feedback. Inductively-coupled series-resonant feedback. R-C oscillators. Crystal oscillators. High-frequency oscillator. Oscillator tuning.	
Chapter 6 . . . Duality in Transistor Circuit Design	76
Meaning of duality. Applications to circuit design. Examples of dual circuits. Practical limitations.	
Chapter 7 . . . Triggers and Switches	82
Nature of switching circuits. Switching through negative resistance. Bistable switching circuit. Monostable circuit. Single shot. Binary counter.	
Chapter 8 . . . Practical Transistor Circuits	89
Single-stage r-c a.f. amplifiers. Single-stage transformer-coupled a.f. amplifiers. Microphone-case preamp. Multistage r-c a.f. amplifier. Multistage transformer-coupled a.f. amplifier. Boosting audio output. Push-pull amplifier for speaker. Hearing aids. Audio oscillator. Code-practice oscillator. Light-powered audio oscillator. Signal injector. Multi-vibrator. Musical toy. Self-excited 100 kc frequency standard. Crystal-type frequency standard. Broadcast-band r.f. amplifier. Broadcast receivers. Phone monitor. Field-strength meter. Amplifier-type d.c. microammeter. D.c. relay. Heterodyne frequency meter. Switching circuit.	
Chapter 9 . . . Tests and Measurements	109
Electrode voltages and currents. Constant-current d.c. supplies. Measurements for characteristic curves. Determination of transistor resistances. Direct measurement of current gain. Voltage gain. Input and output impedance. Frequency response. Switching characteristics.	
Chapter 10 . . . Characteristics of Commercial Transistors	126
Index	139

Preface

THE purpose of this book is to provide an elementary explanation of transistor theory and operation for the thousands of practical electronic workers.

A comparatively enormous quantity of periodical literature has appeared during the transistor's first five years. Unfortunately, however, much of the explanatory material, chiefly from the pens of advanced physicists, has been so involved mathematically as to be completely useless to the practical man and not too well understood by some engineers.

In this book, I have tried to tell in simple language how transistors work and what their circuits are like. I hope I have achieved my purpose without too often falling into the sin of oversimplification. It is hoped that this work will fill the present need for an introductory text.

Assisting in the effort have been numerous organizations which have furnished data or illustrations. Grateful acknowledgment is made here of such material, and for the permission to make use of it, received from Bell Telephone Laboratories, CBS-Hytron, Federated Semiconductor Co., General Electric Co., Hydro-Aire, Inc., National Bureau of Standards, National Union Radio Corp., Radio Corporation of America, Radio Receptor Co., Inc., Raytheon Manufacturing Co., Sylvania Electric Products, Inc., Texas Instruments, Inc., Transistor Products, Inc., Western Electric Co., and Westinghouse Electric Corp.

Data on the surface-barrier transistor were obtained through the courtesy of the Philco Corporation and PROCEEDINGS OF THE I. R. E.

A tremendous amount of work, absorbing some of the most talented minds in the field, is constantly being carried on in transistor electronics. Undoubtedly, this will result in many new theories, reworked older ones, further transistor types, and new circuits. In the meantime, the text is offered with the sincere hope that it will enable many practical men to take their first step less falteringly into the realm of the transistor.

RUFUS P. TURNER

Chapter 1

Semiconductor Theory

IT is the nature of some solid materials to form themselves into bodies called *crystals* which have characteristic geometric shapes. These are the crystalline substances. Exact opposites are those other solids which form into shapeless masses and are said to be plastic, noncrystalline, or *amorphous*. Among very familiar examples, a block of rubber is amorphous, while a slab of salt-cake is crystalline. Quartz may be given a high polish and may be as transparent as glass, but quartz is crystalline and glass is not. Elements and compounds both can be crystalline. So can metals and nonmetals. Virtually all minerals are crystalline.

Externally, a crystal has several flat faces which are arranged symmetrically with respect to each other. This calls to mind the shape of a cut gem such as a diamond. Internally, it has a certain orderly arrangement of atoms into a repeating system called a *lattice*. Both externally and internally, one crystal of a given true crystalline material looks like all other crystals of that material. For example, a crystal of quartz is a hexagonal rod with a pyramid point on each end, one of sodium chloride (common table salt) is block-shaped, and crystals of one form of sulphur are long and needle-like. A single crystal may be large to the point of hugeness or it may be so small as to be visible only with the aid of magnification.

Plates, bars, or slabs of material often are cut from a single crystal and these pieces themselves become erroneously termed crystals. An example is the so-called quartz *crystal* used in radio. Actually, this is a quartz *plate* sliced from a quartz crystal. Ger-

manium wafers, used in diodes and transistors, often are called crystals for the same reason.

Inside the crystal lattice, certain loosely-bound electrons (called *valence electrons*) in the outer rings of one atom align themselves with similar electrons in adjacent atoms to form *valence bonds* which hold the atoms together in the orderly structure of the lattice. Thus, in the valence bond there are shared electrons, so called because they are shared by neighboring atoms.

Electrons and holes

Some crystalline materials have electrical characteristics which may be regarded as intermediate between those of conductors and those of insulators, hence are termed *semiconductors*. Under ordinary conditions, semiconductors are neither good insulators nor good conductors, but can be made to exhibit some of the properties of each. Among the semiconductors having practical importance in modern electronics are cadmium sulphide, copper oxide, copper sulphide, germanium, lead sulphide, selenium, silicon, and silicon carbide (carborundum). Many other elements and compounds have been found to possess semiconductivity in varying amounts.

To understand the nature of a semiconductor, it is necessary to look into the atomic arrangement of the crystal. At low temperatures, no electrons in a true semiconductor are available to carry current through the material because the loosely-bound electrons which ordinarily would be available for that purpose are held in the valence bonds. The material therefore has the features of an insulator, or at least of a very high-value resistor. If the crystal structure were perfect and all valence bonds satisfied, the material would support no current flow at all and would be an insulator in the truest sense. Based upon advanced quantum-mechanical theories of matter and verified by experiments, we know that a crystal of *pure* germanium (one having identical atoms uniformly spaced) will not conduct at all. The germanium diode, widely used as a detector in radio and TV, conducts because of the presence of impurities. The atoms of a crystal of germanium, like all other atoms, contain a nucleus surrounded by rings or orbits of electrons. These rings, often likened to a miniature solar system with the sun analogous to the nucleus, remain bonded to the nucleus. Electrons, however, can be added to or taken away from the outermost ring. Atoms of the element phosphorus have an outer ring which contains one more electron than

the outer ring of germanium. Adding phosphorus (or antimony, arsenic, etc.) to germanium produces an *excess* electron condition. Particularly at higher temperatures, thermal agitation causes some of the valence electrons to be knocked out of the bonds and thus to become available for current flow. The material then assumes the features of a conductor. As the semiconductor material is heated further, more electrons are freed to drift through the crystal lattice in response to an applied electric field, and the conductivity of the material increases (resistance decreases). Quite apart from heat action, electrons in some semiconductors may also be dislodged from the valence bonds at ordinary temperatures by the action of light shining upon the material. This photoelectric action is utilized in the selenium photocell of the photographic exposure meter. Bombardment by other forms of radiation likewise has been observed to release electrons in semiconductors.

A somewhat different situation exists when we add a material which contains *less* electrons in its outermost orbit when compared to germanium. Elements such as boron, aluminum, or gallium, have *one less* electron than germanium. Since we now have an inadequate number of electrons surrounding the nuclei of the atoms, we say that the orbit has *holes* in it. Furthermore, these holes can move just as though they were positive charges. This apparently fantastic concept can be mathematically proved and verified experimentally. However, you can consider it in this manner. An electron is a basic negative charge. When an electron jumps out of a valence bond, it leaves behind an empty *hole* which, representing a deficiency of negative charge, appears as a net positive charge. Another electron, under attraction by the positive electrification, may jump into the hole. This leaves a hole farther back which then may be filled by a nearby electron, leaving still another hole. It is in this way that holes are conceived of as drifting through the lattice. Usually, a certain amount of recombination goes on between holes and electrons, a hole-electron pair recombining to restore the original condition of the material.

Some imperfect semiconductor materials have an excess of electrons. In these materials, current flow results principally from electron movement. Such semiconductors are termed *N-type* (*N* signifying the negative polarity of the electron). Other semiconductors have an abundance of holes. Conduction in these lat-

ter materials is by the drift of holes. Hole-rich semiconductors are termed *P-type* (*P* referring to the positive polarity of the hole). Thus, the type of current carrier determines the classification of the semiconductor material. *Intrinsic* semiconductors are those materials in which only a small amount of energy is required to displace electrons from valence bonds. At ordinary temperatures, electrons and holes are generated in pairs and recombine continuously in intrinsic semiconductors. The useful intrinsic semiconductor elements for electronic applications are in the 4th column of the Periodic Table. The Periodic Table is found in most elementary text-books on chemistry.

When an electric field is applied to a piece of intrinsic semiconductor material (for example, by placing a positive electrode on one end and a negative electrode on the other), electrons drift through the crystal lattice toward the positive electrode and holes toward the negative electrode. This constitutes a flow of current. Electron movement and hole movement may be regarded as separate manifestations of the same phenomenon. Although electrons and holes move simultaneously in opposite directions, the current component which their separate movement constitutes is in one direction.

The conduction characteristics of a semiconductor can be altered considerably by mixing a minute quantity of a selected impurity, metallic or nonmetallic, into the semiconductor material. Atoms of the impurity material must be small enough to fit into the crystal lattice where they replace a few of the semiconductor atoms. When the atoms of the impurity material have more valence electrons than are required to satisfy the valence bonds with adjacent semiconductor atoms, loose electrons will be left over and will be free to participate in current conduction. Such an impurity therefore will make the semiconductor strongly N-type. An impurity of this type is termed a *donor* since it donates electrons. If, instead, the impurity atoms have less valence electrons than are needed to satisfy the valence bonds, holes will occur in each bond where an electron is missing. These holes are available for current conduction and the semiconductor material will be strongly P-type. An impurity of this kind is termed an *acceptor*, since the holes it creates accept electrons.

Thus, by proper choice of the impurity material with respect to its own electronic constitution, the semiconductor may be made either N-type or P-type as desired. It is interesting to note

that the proper amount of added impurity in some transistor semiconductors may be as small as 1 impurity to each 10 million semiconductor atoms. When the original semiconductor material is an element from Column 4 of the Periodic Table, donor impurities can come from Column 5 and acceptor impurities from Column 3.

Fig. 101 is a simplified representation of a donor-impurity atom in part of a semiconductor crystal lattice. Here, each semiconductor atom has 4 valence electrons and the impurity atom has 5. Four of the valence electrons of the impurity atom join with those of adjacent semiconductor atoms to form valence bonds. All valence bonds being satisfied, the extra electron of the impurity atom is not held firmly in the structure and is free to move through the crystal lattice. Mixing atoms of this type into the semiconductor thus makes the latter N-type.

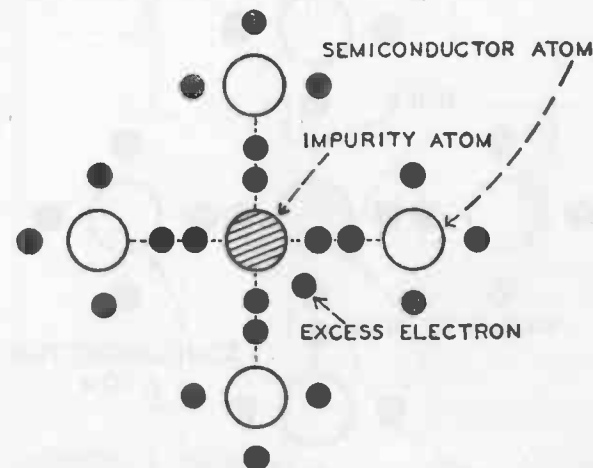

Fig. 101. Donor-impurity atom in semiconductor.

Fig. 102 is a simplified picture of an acceptor-impurity atom in part of a semiconductor crystal lattice. In this case, as before, each semiconductor atom has 4 valence electrons. But the impurity has only 3. Only three valence bonds with neighboring semiconductor atoms therefore are satisfied. (A fourth impurity electron would be required to complete the bond between the impurity atom and the top semiconductor atom.) A hole accordingly appears in what would have been the upper bond. An available electron from somewhere else in the lattice can move into this particular hole, thus leaving a hole behind. The hole provided by the impurity atom thus can migrate through the lattice under

the proper conditions. Mixing this type of impurity into the semiconductor makes the latter P-type.

It must be remembered that these are purely graphic representations of hypothetical semiconductors and impurities in which all of the inner electrons and the nuclei of each of the atoms have been ignored. The electrons do not necessarily align themselves in the simple manner shown. Nor has any attention been paid to orbital movement of the electrons. However, the pictures presented give some background for understanding how semiconductor properties are modified by doping these materials with selected impurities.

It has been mentioned that electron and hole activity within

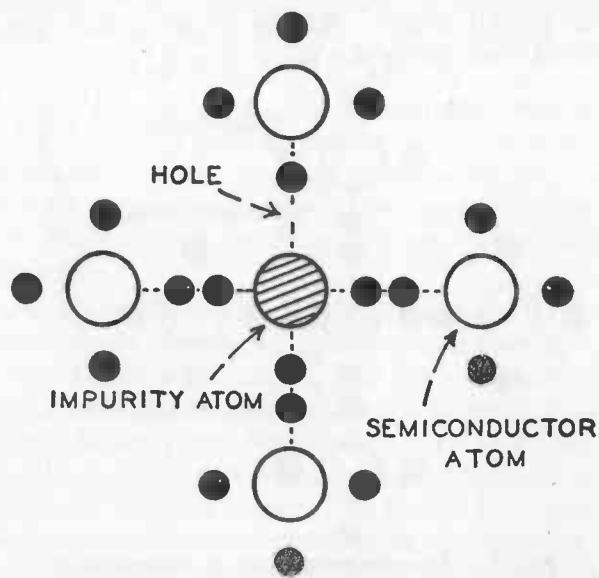

Fig. 102. Acceptor-impurity atom in semiconductor.

the semiconductor crystal lattice is accelerated at high temperatures. Conductivity increases during heating. Semiconductors therefore exhibit a negative temperature coefficient of resistance.

Current moves more slowly through a semiconductor than in a true conductor. Electrons drift more slowly because they encounter obstructions due to crystal imperfections. Hole movement is even slower because of their jump-by-jump progress between valence bonds. The total current may fall short of expected values because of the devious routes taken by some of the carriers, a phenomenon known as *spreading*.

Germanium

At this writing, germanium is the most important semiconductor used in the manufacture of transistors. Silicon presently is receiving attention because of its ability to operate at higher temperatures, but today commercial transistors all are germanium devices. Germanium is a grayish-white metallic element. In some of its properties it resembles carbon, while in others it resembles tin. It is found in the 4th column of the Periodic Table and has an atomic weight of 72.60.

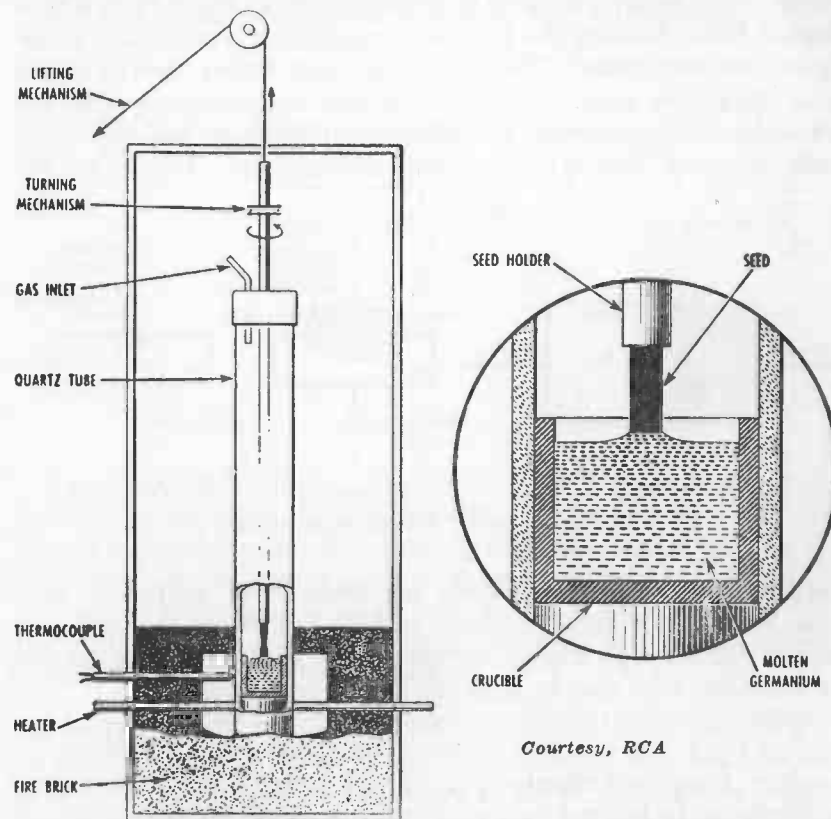

Fig. 103. One type of apparatus for growing single crystals. Rotated seed is slowly withdrawn. Inset shows early stage as the crystal starts to form.

Germanium was predicted in 1871, although never seen, by Dmitri Mendelyev who called it eka-silicon. It was discovered physically by Clemens Winkler in 1886 and was named in honor of Germany, Winkler's native country.

Metallic germanium is secured by reduction (in a hydrogen

or helium atmosphere) of germanium dioxide, a gray powder. The dioxide is obtained in commercial quantities in the United States as a flue residue in zinc smelting, and in England as a component of the chimney soot from gas works.

After purified germanium has been produced by electronic manufacturers and doped to specifications, comparatively large *single* crystals of it (as shown in Fig. 103) are drawn from a melted mass of the metal by dipping in a seed crystal of germanium and withdrawing it slowly under rotation. The melted germanium adheres and follows the seed to be pulled out of the melt in single-crystal form. During the process, temperature is controlled closely and air is excluded. The tiny germanium wafers used in diodes and transistors later are cut out of this single crystal. The advantages of single-crystal material are uniformity and reproducible electrical characteristics, such as resistivity. When, on the

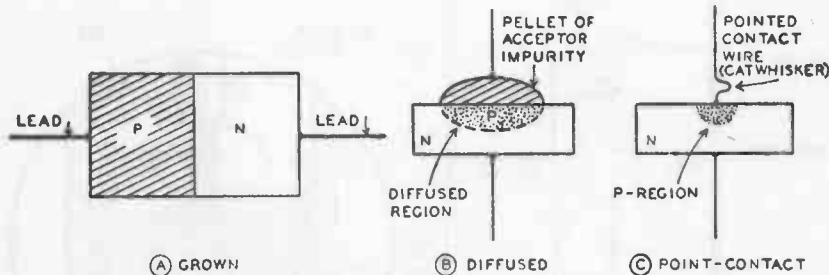

Fig. 104. Types of P-N junctions (diodes).

contrary, a germanium sample is composed of numerous intimately-bonded separate crystals, wafers sliced from this material might cut through crystal interfaces and exhibit nonuniformity of characteristics due to separate crystal properties.

While the germanium is in the molten state, impurities of the proper kind and amount are added to make it either N-type or P-type, as required. Without controlled doping, pure germanium would behave like an insulator. Later, during the single-crystal drawing, impurities may be added also at proper times during the withdrawal to produce separate N and P layers in the same crystal. Most general-purpose germanium is prepared to be N-type.

P-N Junction, semiconductor diode

The junction between a P region and N region in single-crystal

germanium is of interest, since it is the foundation of both diode and transistor action.

Fig. 104 shows three types of such junctions. In Fig. 104-a, P and N regions have been *grown* into the germanium block by mixing acceptor and donor impurities, respectively, into the single crystal during its formation. This is known as a *grown junction*. Note that the grown-type of P-N junction is not a sandwich made by attaching a P block to an N block, but actually consists of P and N layers in a single piece of germanium. Considerable misunderstanding has arisen regarding this arrangement.

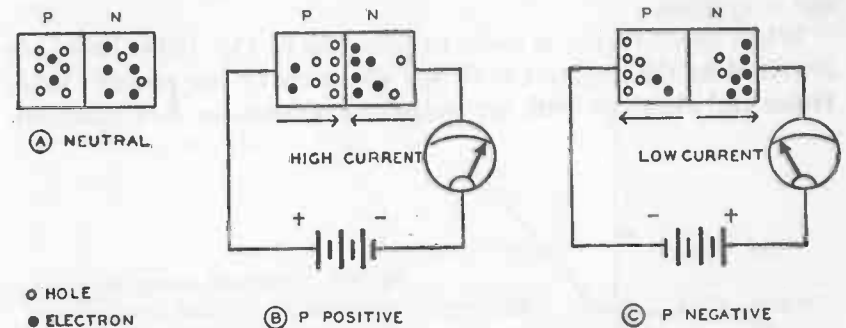

Fig. 105. Effect of junction bias voltage.

The *diffused junction* in Fig. 104-b is made by placing a pellet of acceptor impurity, such as indium, on one face of a wafer of N-type germanium and then heating the combination to melt the impurity. Under proper conditions of temperature and time, a portion of the impurity metal will diffuse a short distance into the wafer, thereby creating a region of P-type germanium in intimate association with the N-type bulk.

Fig. 104-c shows a point-contact type. Here, a fine, pointed wire ("catwhisker") makes pressure contact with the face of an N-type germanium wafer. After assembly, the device is formed by passing a high-current surge momentarily across the junction of wafer and whisker. The heat generated during the short interval drives a few electrons from the atoms in the region of the point contact, leaving holes and thus converting into P-type a small volume of germanium immediately under and around the point.

Fig. 105 shows what happens when a steady d.c. bias voltage is applied between the P and N portions of a junction. In Fig. 105-a, no voltage is applied. The P region has holes (white), and

the N region electrons (black) available as carriers. Note that a few electrons may be seen in the P region, and a few holes in the N region. But in each case, these *minority carriers* are far outnumbered by the *majority carriers* and so can make no substantial contribution to any current conduction.

When the P region of the junction is made positive, as in Fig. 105-b, the holes are repelled by the positive field and the electrons by the negative field. Both holes and electrons are driven, in the direction of the arrows, toward the P-N junction where they recombine. A high current flows, since the junction resistance appears low. The process continues as long as the bias voltage is applied.

When the P region is made negative, as in Fig. 104-c, holes are attracted by the negative field and electrons by the positive field. Holes and electrons both are pulled away from the P-N junction,

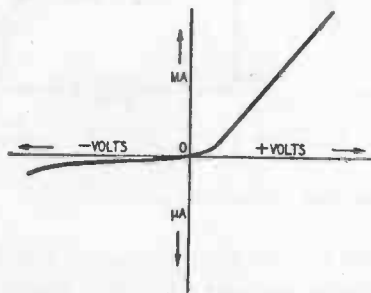

Fig. 106. Static volt-ampere characteristic curve of a typical semiconductor diode.

in the direction of the arrows. There can be no significant recombination, and the junction resistance appears high. As a result of this action, the current flow is low.

We say that the junction is biased in the *forward direction* in Fig. 105-b. This is the direction of low resistance, high conductance, or high current. Conversely, the junction is biased in the *reverse direction* in Fig. 105-c. This is the direction of high resistance, low conductance, or low current. A *potential barrier* is said to be set up when the junction is reverse-biased.

The P-N junction is a rectifier because of this ability to pass current more readily in one direction than in the other. Its rectification efficiency is proportional to the ratio of its forward and reverse resistances. This is the diode rectifier which has been the most widely exploited semiconductor device. Two varieties of diodes are manufactured—the junction type (of which Fig. 104-a and Fig. 104-b are illustrative) and the point-contact type, the

basic arrangement of which is shown in Fig. 104-c. However, if the concept of a formed P-area around the point-contact whisker is accepted, then all diodes may be regarded as being of the junction type.

Fig. 106 shows the static volt-ampere characteristic curve of a typical semiconductor diode. Note that the forward current is in milliamperes, while the reverse current is only a few microamperes. The positive and negative portions of the curve are seen to be nonlinear over a considerable portion of their ranges.

Fig. 107 shows the static resistance (E/I) characteristic of a semiconductor diode. As the forward voltage is increased, the

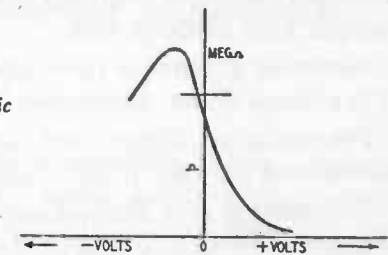

Fig. 107. Static resistance characteristic of a semiconductor diode.

resistance falls to a low value, usually 100 ohms or less. At decreasing values of forward voltage, the resistance increases until, near zero voltage, it is in the hundreds of thousands of ohms. As the reverse voltage is increased, the resistance passes through a peak in the hundreds of thousands of ohms (or in the megohms) and then decreases. There is a burnout point at the positive and negative extremes of this curve, as also in the curve in Fig. 106.

Hole and electron injection

When a positive bias is applied to the P region of a P-N junction or to the whisker of a conventional point-contact germanium diode valence electrons from nearby atoms flow to the P region or to the whisker. This is equivalent to stating that holes flow from the P region or whisker. Another point of view is that, with the same bias polarity, the N-region injects electrons into the P-type germanium.

This concept of carriers (whether holes or electrons) being injected into the body of the semiconductor material is essential to an understanding of the mechanics of transistor operation.

In the next chapter, we shall see that carrier injection into a semiconductor is a basic phenomenon which is analogous to electron emission by the cathode of a vacuum tube.

RECOMMENDED READING

1. *Modern Theory of Solids*. (Book). Frederick Seitz. (McGraw-Hill Book Co., Inc., New York, N. Y., 1940).
2. *The ABC's of Germanium*. J. P. Jordan. ELECTRICAL ENGINEERING. July 1952.
3. *Single-Crystal Germanium*. G. K. Teal, M. Sparks, and E. Buehler. PROCEEDINGS OF THE I.R.E., August 1952. p. 906.
4. *P-N Junctions Formed by Impurity Diffusion*. R. N. Hall and W. C. Dunlap. PHYSICAL REVIEW. November 1952. p. 467.
5. *The Theory of P-N Junctions in Semiconductors and P-N Junction Transistors*. William Shockley. BELL SYSTEM TECHNICAL JOURNAL. July 1949. p. 450.
6. *Survey of Transistor Development. Part 1*. B. N. Slade. RADIO & TELEVISION NEWS. September 1952. p. 43.
7. *Properties of Silicon and Germanium*. Esther M. Conwell. PROCEEDINGS OF THE I.R.E., November 1952. p. 1327.
8. *Germanium and Radio-Electronics*. Rufus P. Turner. RADIO-TELEVISION SERVICE DEALER. May 1953. p. 41.
9. *Transistors*. John R. Pierce. RADIO-ELECTRONICS. June 1953. p. 42.

Chapter 2

Transistor Characteristics

THE transistor is a semiconductor amplifier device. Its amplifying and control properties suit it also to oscillator and switching functions. In operation and application, the transistor bears somewhat of a resemblance to the vacuum tube, but is different from the tube in several important respects. In the tube, electrons are liberated into an evacuated space, and their drift toward a positively-charged plate electrode constitutes a current flow. Amplification results from the fact that this current can be controlled and modulated by a small signal voltage.

In the transistor, either holes or electrons are injected into the solid body of a semiconductor and their movement through the material constitutes a current flow which likewise can be modulated by a signal voltage. The fundamental differences between tubes and transistors result from the mechanism of control. In the tube, the electron current is modulated electrostatically by a signal voltage. Under ordinary circumstances, no signal current is required. The tube thus is a voltage-actuated high-impedance device. But in the transistor, signal energy is required to modulate the injection of carriers into the semiconductor in order to modulate the carrier current. This corresponds to current variation. A signal source employed with a transistor accordingly must deliver current, and the transistor is a low-impedance current-actuated device.

Transistor types

Present practical transistors are triodes, having three elec-

trodes which correspond roughly to cathode, grid, and plate of a triode tube. The two types which are in current manufacture are the *point-contact* and *junction* transistors. Fig. 201 shows the main features of these types.

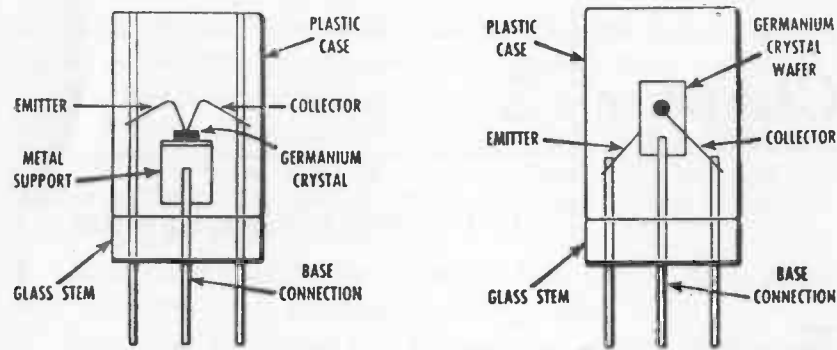

Courtesy, RCA

Fig. 201. Essential features of point-contact and junction transistors.

Each basic type of transistor has the following electrodes: an *emitter* which serves to inject carriers into the *base*, and a *collector* which attracts the carriers through the base-region. The emit-

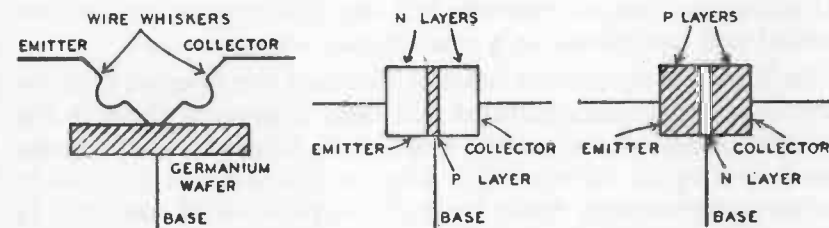

SYMBOLS—

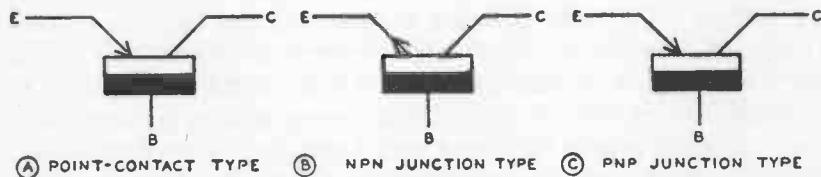

Fig. 202. Point-contact and junction type transistor triodes.

ter corresponds to the cathode of a vacuum tube, the base to the grid, and the collector to the plate.

Fig. 202-a shows the arrangement of a point-contact transistor. This type resembles a point-contact diode with an extra cat-whisker. The two whiskers make pressure contact with the face of a germanium wafer (commonly N-type). One whisker serves as the emitter, the other whisker as the collector, and the germanium wafer as the base. The points of the whiskers are closely spaced on the germanium, usually being separated by 0.002 or 0.003 inch. A large-area, low-resistance contact is made to the

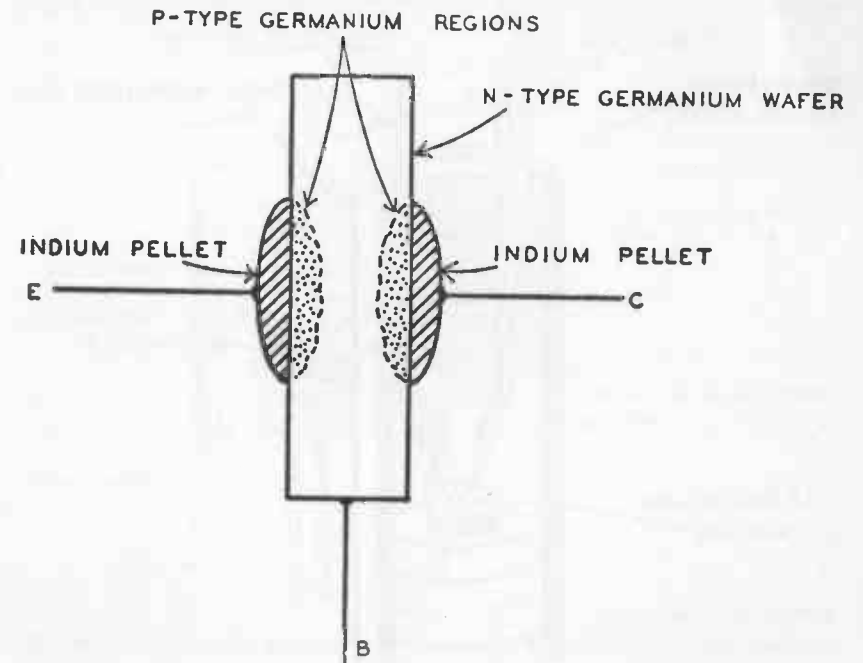

Fig. 203. Construction details of diffused P-N-P transistor junction.

base. The three connections terminate in pigtailed or pins for external access.

Fig. 202-b shows an ideal cross section of a junction transistor of the N-P-N type. Here, careful processing has produced a thin P-type layer between two N-type layers in the same block or wafer of single-crystal germanium. One N-layer is the emitter, the other N-layer the collector, and the central P-layer is the base. The latter is very thin, often 0.001 inch. Low-resistance connections to the three layers terminate in pigtailed or pins.

Fig. 202-c illustrates an ideal cross section of a junction transistor of the P-N-P type. In this unit, a thin N-layer is processed

between two P-type layers in the same block or wafer of germanium. Here, the P-layers are emitter and collector, and the central N-layer is the base. The N-layer is very thin, often 0.001 inch or less. Low-resistance connections to the three layers terminate in pigtailed or pins.

The point-contact transistor is seen to resemble the point-contact diode (Fig. 104-c), and the junction transistors the junction diode (Fig. 104-a and Fig. 104-b), with one extra electrode

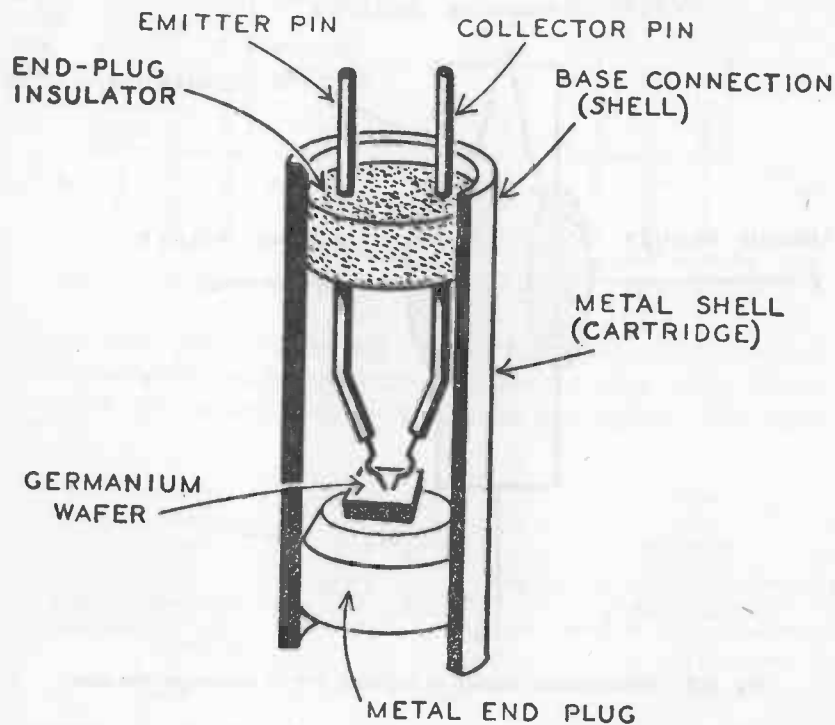

Fig. 204. Cutaway view of point-contact transistor assembly.

provided in each instance. In Fig. 202, the corresponding standard symbol is shown with each type of transistor. Note that the same symbol is used for both point-contact and P-N-P types.

As in the junction diodes, the layers of the junction transistors may be of the grown-type or diffused-type. The grown-type is obtained by adding the required impurities during the process of single-crystal pulling to create the adjacent N and P layers. This is the most difficult type to manufacture. Fig. 203 shows the

cross section of a diffused-junction P-N-P type. Here, a pellet or button of indium (or boron, gallium, etc.) is melted on each face of a thin wafer of N-type single-crystal germanium. Some of the indium diffuses into the germanium from each side, creating P-type regions in the wafer. The process is continued until the separation between the two P-regions is very narrow (say 0.001 inch) but is halted before short circuit occurs. In practical diffused-junction P-N-P transistors, the emitter pellet is somewhat smaller in size than the collector pellet.

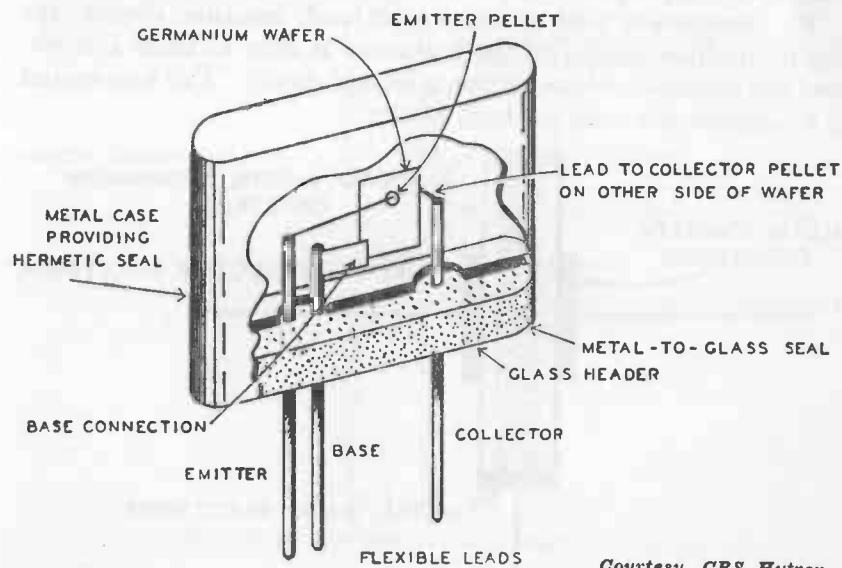

Fig. 205. Cutaway view showing inner construction details of junction transistor. Courtesy, CBS Hytron

Transistors of both types are manufactured to several mechanical designs. Fig. 204 is a cutaway view of one style of point-contact transistor. This type is housed in a metallic cartridge, shell, or barrel and is intended for insertion into a special sub-miniature socket. The two pins fit into the socket clips, while the transistor shell (base connection) is gripped by the socket ring or spring. The germanium wafer is soldered to the metal end plug or to a metal pin passed through this plug. The plug makes a tight-fit contact with the shell to form the low-resistance base connection.

Fig. 205 is a cutaway view of a junction transistor of one style of construction. Here, the germanium wafer is supported ver-

tically. A large metal tab is attached to the lower end of the wafer to form a low-resistance base connection. The opposite end of the tab is attached to the base lead or pin. The emitter, base, and collector leads pass through the insulated bottom of the assembly and are intended for insertion into the clips of a sub-miniature tube socket or for soldering or welding into a circuit. The assembly shown in Fig. 205 is used for hermetically-sealed and evacuated transistors as well. After assembly, a protective wax is injected into nonevacuated transistors through a hole provided for the purpose, after which the hole is sealed.

By comparison with point-contact and junction diodes, the emitter-to-base section of the transistor is seen to form a diode, and the collector-to-base section a second diode. The base-region is a common electrode for both diodes.

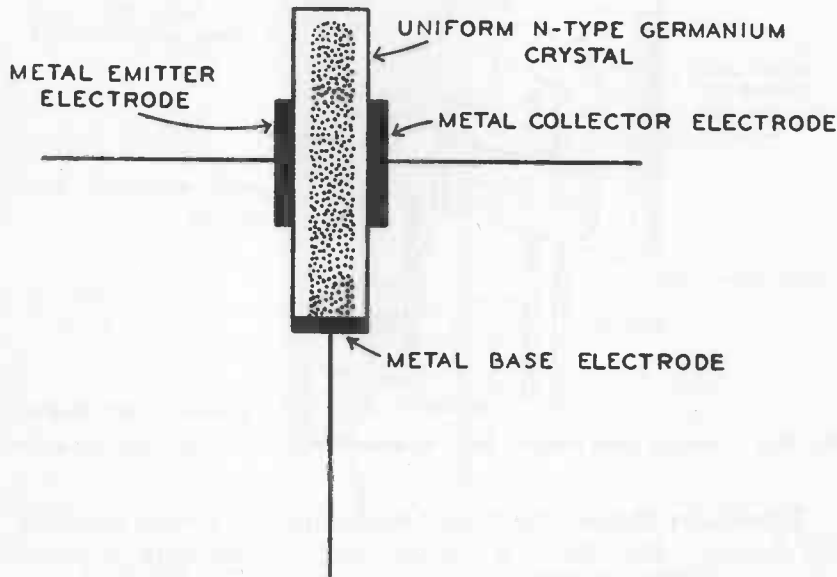

Fig. 206. Schematic cross-section of surface-barrier transistor.

Surface-barrier transistor

A third class of transistor, the *surface-barrier* type, has been developed and extensively tested by the Philco Corporation but is not available commercially at this writing. While it resembles the P-N-P junction type somewhat in general appearance, the surface-barrier transistor is unique in that it contains only one type of germanium, N-type. Metal emitter and collector electrodes

of indium are *plated* on opposite faces of an extremely thin portion of an N-type germanium wafer cut from single-crystal material (see Fig. 206.) No diffusion of the metal takes place into the germanium.

Beneath the emitter and collector electrodes lies a thin barrier layer, approximately 1/10,000 of an inch thick, which contains almost no electrons or holes. This is represented by the white region in Fig. 206. The barrier layer extends slightly into the crystal. It is an almost perfect insulator and has a strong electric

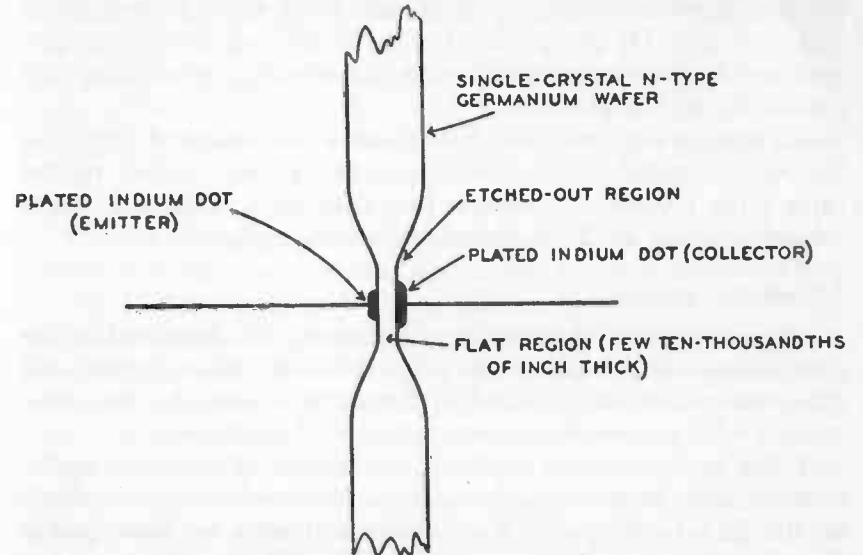

Fig. 207. Detail of surface-barrier transistor cross-section.

field and so is analogous to a capacitor. The field repels free electrons *into* the crystal, from the surface. The free electrons from the interior atoms of the crystal are in effect driven back down and the barrier remains swept clean of such carriers.

Surface-barrier transistors are produced by an electrolytic etching and plating process in the following manner: Two fine streams of indium sulphate solution are played upon axially-opposite points on the faces of the N-type germanium wafer. At the same time, a direct current is passed through the germanium and solution in such a direction as to remove germanium electrolytically from the faces of the wafer. The tiny sprayed areas thus are gradually etched away. When the desired wafer thickness (a few ten-thousandths of an inch) has been reached, the etching process

is arrested abruptly by suddenly reversing the direction of current flow. This reversal causes an indium-metal dot to be plated on each opposite face of the etched-out area (see Fig. 207). Leads then are attached to the emitter and collector dots and to the wafer (base), and the unit is mounted in a hermetically-sealed enclosure similar to Fig. 204.

The electrolytic process has several advantages: (1) The wafer thickness can be controlled within a few millionths of an inch, (2) the opposite faces of the etched-out area are almost perfectly flat and parallel, (3) the liquid streams keep the work both clean and cool, and (4) the plating process is effected on a clean germanium surface *immediately* after the etching, precluding any possibility of contamination.

Advantageously small-sized electrodes are obtained with the electrolytic etching and plating process. Philco reports typical units with 0.003-inch emitters and 0.006-inch collectors and a barrier spacing of 2 ten-thousandths of an inch.

Transistor action

The exact, detailed behavior of a transistor is described in the complicated mathematical language of solid state physics and quantum mechanics. Abundant literature is available for those readers who are inclined toward advanced mathematics.

A first explanation of the basic mechanism of transistor operation can now be made with the aid of 10 condensed facts which we are in a better position to understand since we have looked into the subjects of diode operation and carrier injection.

1. A steady d.c. bias voltage (v_c) is applied between collector and base with polarity such that reverse current (i_c) flows through the collector diode.

2. The reverse-biased collector diode appears as a high resistance (r_c).

3. A steady d.c. bias voltage (v_e) is then applied between emitter and base with polarity such that forward current (i_e) flows through the emitter diode.

4. The forward-biased emitter diode appears as a low resistance (r_e).

5. The emitter injects carriers into the base-region. The polarity of these carriers is opposite to the polarity of the collector. The carriers accordingly are drawn through the base-region toward the collector by action of the latter's field.

6. On their way to the collector, a few of the carriers recom-

bine with carriers of opposite polarity in the base-region and thus are neutralized. But most of them reach the collector where they increase the collector current. This is the fundamental mechanism whereby current amplification (or at least emitter-collector control interaction) occurs in a transistor.

7. Current amplification may be expressed as the ratio of the change in collector current (di_c) to a given change in emitter current (di_e) when collector voltage (v_c) is held constant. *Current amplification factor* (di_c/di_e) is represented by the Greek letter alpha (α).

8. When every carrier leaving the emitter reaches the collector, alpha equals 1. In other words, the collector-current change is equal to the emitter-current change. Alpha is less than 1 (but close to unity) in junction transistors, and can be greater than 1 in point-contact transistors.

9. The transistor exhibits voltage gain and power gain, as well as current gain when it is operated in satisfactory circuits.

10. Voltage gain and power gain are obtained even when alpha is less than 1, because the output (e.g., collector) electrode has a higher impedance than the input (e.g., emitter) electrode. However, the emitter is not always used as the input electrode, nor the collector always as the output electrode.

Figs. 208-a, -b are enlarged sketches showing how bias and signal voltages are applied to transistors. Circuit diagrams illustrating transistor connections are shown in Fig. 209. In the N-P-N junction transistor (Fig. 209-a), the current carriers are electrons. The negatively-biased emitter injects electrons into the base-region. Under the influence of the strong positive field of the collector, these electrons diffuse through the thin base-region to the collector junction where they augment the collector current. A few of the electrons combine with holes in the hole-rich P-germanium base-region. But the base layer is very thin, so most of the electrons reach the collector. However, since recombination and other effects prevent the electrons *all* reaching the collector, alpha (current amplification factor) for the N-P-N transistor can never reach a value of 1, although it attains values as high as 0.98 and 0.99 in some commercial units. The emitter bias is negative for the N-P-N type and the collector bias is positive. This is similar to negative grid bias and positive plate voltage in vacuum-tube circuits. The input signal is applied in series with the emitter bias in the example shown, and the amplified output signal is developed across the collector load resistance.

with the *motion* of the injected holes permits each hole to accelerate more than one electron of collector current. Another (the "P-N hook theory"), more widely accepted at this writing, explains that the collector is a complex structure comprising a separate transistor all by itself and that this second transistor is an amplifier electron-coupled to a first transistor structure in the main body of the unit.

In each type of transistor, the emitter bias voltage is lower than the collector bias voltage. This is understandable when we consider that the emitter diode is biased in the forward direction and consequently exhibits low resistance, while the collector diode is biased in the reverse direction and exhibits high resistance.

Transistor configurations

The emitter is not always used as the signal-input electrode, nor the collector always as the signal-output electrode. A transistor can be connected into a single-stage circuit in any one of three

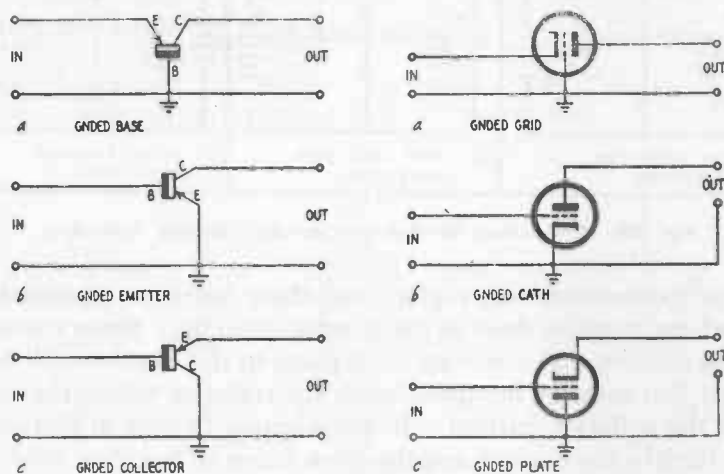

Fig. 210. Transistor amplifier configurations with equivalent tube circuits.

basic ways, depending upon the type of operation desired, and its amplifying or control characteristics depend upon which method of connection is used. It is advisable at this time to describe these three configurations in order to facilitate an understanding of the discussions which follow. This description is made here for purposes of identification only, and will not be complicated now by explanations of performance. They will come later in this chapter.

Fig. 210 shows the three basic configurations with approximately equivalent tube circuits for comparison. Transistor connections of these three types are employed in single-stage amplifiers, oscillators, trigger circuits, and control circuits. Elaborations of the basic configurations also are employed. For simplicity, all bias-voltage supplies and external circuit components have been omitted.

Fig. 210-a shows the *grounded-base* circuit. The input signal is applied between emitter and base, and the amplified output signal is taken between collector and base. This configuration is analogous to the grounded-grid tube circuit.

Fig. 210-b shows the *grounded-emitter* circuit. The input signal is applied between base and emitter, and the amplified output signal is taken between collector and emitter. This configuration is analogous to the grounded-cathode tube circuit. Fig. 210-c shows the *grounded-collector* circuit. The input signal is applied between base and collector, and the amplified output signal

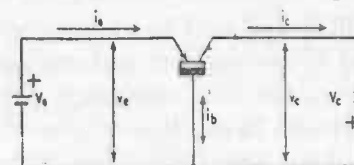

Fig. 211. Basic transistor parameters.

is taken between emitter and collector. This configuration is analogous to the cathode-follower tube circuit. Each of the three basic transistor circuits partakes of some of the characteristics of the equivalent tube circuit. D.c. biasing of the surface-barrier transistor is the same as specified for P-N-P junction transistors. Emitter is positive and collector is negative with respect to base.

Transistor parameters

The basic parameters of a transistor are emitter voltage (v_e), emitter current (i_e), collector voltage (v_c), collector current (i_c), and base current (i_b). It is customary to represent all transistor parameters with lower-case letters, and to use capitals for external-circuit parameters. Thus in Fig. 211, v_e is the transistor emitter-to-base voltage, while V_e is the emitter-voltage supply.

Fig. 211 shows a grounded-base transistor connected directly to emitter and collector d.c. bias supplies, and with the basic currents and voltages indicated. For simplicity, no external-circuit elements other than the two batteries are shown. Emitter and col-

lector resistive parameters may be determined from the basic voltages and currents. For example, the static resistance (r_c) of the collector diode = v_c/i_c . Emitter and collector power dissipation (P) likewise may be determined. ($P = vi$).

Resistive components

With respect to internal resistance components "seen" from its three terminals, the transistor may (at d.c. and low audio frequencies) be represented by an equivalent 3-terminal network such as is shown in Fig. 212. Actually, the network shown in this

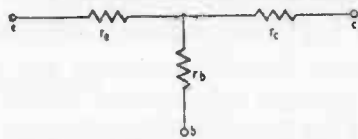

Fig. 212. Simplified equivalent 3-terminal resistance network of transistor.

illustration is simplified and will be elaborated upon in Chapter 3. Resistances r_e and r_c are emitter and collector resistances, respectively. Resistance r_b , the base resistance, depends upon the resistivity of the germanium in the base-region of the transistor and upon the resistance of the base connection, although other factors also might govern its value to some extent.

The effect of these resistive components upon input and output resistances of the transistor in various circuit configurations may be observed from Table 1.

Table 1—TRANSISTOR CIRCUIT INPUT AND OUTPUT RESISTANCES

CONNECTION	INPUT RESISTANCE	OUTPUT RESISTANCE
Grounded-base	$r_e + r_b$	$r_c + r_b$
Grounded-emitter	$r_b + r_e$	$r_c + r_e$
Grounded-collector	$r_b + r_c$	$r_e + r_b$

Characteristic Curves

Because the transistor is a current-operated device, current is taken as the independent variable in the measurement and specification of transistor characteristics. Thus, emitter or collector current is varied in test operations and the resulting emitter or collector voltage is observed. In tube technique, on the other hand, electrode voltages are varied and the corresponding currents noted.

Transistor current vs. voltage characteristics are specified with respect to a *constant-current* parameter. This is in contradistinction to the vacuum tube, a voltage-operated device, whose voltage vs. current characteristics are specified with respect to a constant-voltage parameter. For example: Each of a family of plate voltage vs. plate current tube curves is plotted for a constant value of grid

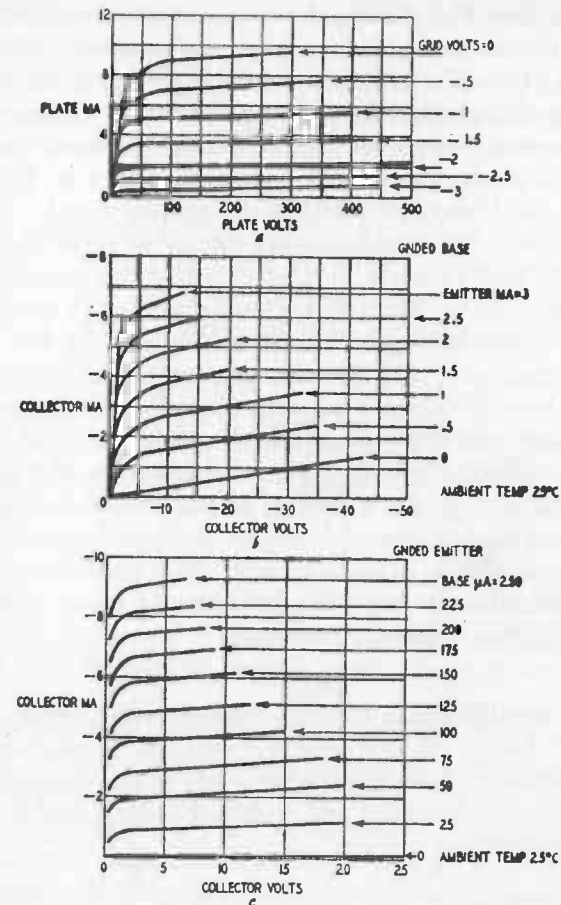

Fig. 213. Transistor collector current vs. collector voltage curves compared with vacuum-tube characteristics.

voltage, while each of a similar set of transistor collector current vs. collector voltage curves is plotted for a constant value of emitter current (for the grounded-base connection) or base current (for the grounded-emitter connection).

Fig. 213 illustrates this point. Two sets of transistor collector current vs. collector voltage curves are shown in comparison with

a set of similar tube plate voltage vs. plate current curves. Observe in Fig. 213 that the transistor collector characteristic curves (Fig. 213-b and Fig. 213-c) have the general shape of pentode tube plate curves. (Fig. 213-a). The tube curves depict variation of plate current (i_p) with plate voltage (e_p) for selected constant values of grid voltage (e_g). The transistor curves for the grounded-base circuit (see Fig. 213-b) show variation of collector voltage (v_c) with collector current (i_c) for selected constant values of emitter current (i_e). The transistor curves for the grounded-emitter circuit (Fig. 213-c) show variation of collector voltage (v_c) with collector current (i_c) for selected constant values of base current (i_b). In each of the families of transistor curves in Fig. 213, we have taken the liberty of rotating the graphs simply to give easy comparison with the accompanying family of tube curves. Properly, current values should be plotted along the horizontal axis of each transistor curve, and voltage values along the vertical axis.

Other characteristics which may be plotted for the grounded-base connection are: (1) Emitter current vs. emitter voltage for constant values of collector current, (2) collector current vs. emitter voltage for constant values of emitter current, and (3) emitter current vs. collector voltage for constant values of collector current. Characteristic (2) is known as the *feedback characteristic*, since it shows the influence of output (collector) current upon input (emitter) voltage. Characteristic (3) is known as the *transfer characteristic*, since it shows the influence of input (emitter) current upon output (collector) voltage.

Alpha

Current amplification factor, (emitter-to-collector) evidenced by a large change in collector current for a smaller or equal change in emitter current correctly refers to the current amplification between emitter input and collector output, and is a property of the grounded-base circuit.

Beta

Current amplification (base-to-collector), beta, is a second type of current amplification obtained in the grounded-emitter circuit where the base is the input electrode. This amplification is designated by β , the Greek letter *beta*.

Beta is especially interesting in the grounded-emitter circuit employing the junction transistor, since it reaches values of 30 to 40 in some units while alpha for the same units is less than 1. The reason for this action is that the base current is very small, com-

pared to the collector current (i_b being the difference between collector and emitter currents). Base-to-collector amplification, beta, may be discerned readily in the grounded-emitter characteristics in Fig. 213-c. Note, for example, that at a collector voltage of 10, a base-current change of 25 microamperes (from the 25- to the 50-microampere curve) results in a collector-current change of 1 milliampere (from the 1- to approximately the 2-ma ordinate). This corresponds to a beta of 40. Beta is di_c/di_b and in terms of alpha is equal approximately to $\alpha/(1-\alpha)$. Hence, it is desirable for high amplification in junction-transistor grounded-emitter applications that alpha be as near unity in value as possible.

Negative resistance

In the point-contact transistor (but not in junction types), when alpha is larger than 1 and the base resistance, r_b , is fairly high or is supplemented with an external base resistor, R_b , the transistor

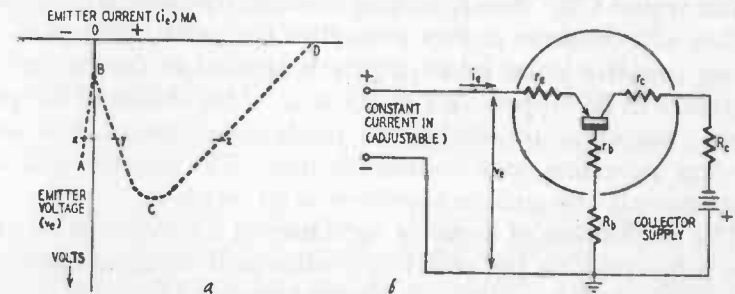

Fig. 214. Point-contact transistor emitter current vs. voltage characteristic.

will exhibit negative resistance characteristics at certain levels of current and voltage. This results from positive feedback and the effect of alpha upon the voltage drop across the base resistance.

Fig. 214 shows emitter current vs. voltage relationships under these conditions. Assume the collector voltage to be held at some constant value. As the emitter current (i_e) is increased positively, the emitter-to-ground voltage (v_e) first will increase *negatively* from B to C and then will decrease from C to D. Further positive increase of i_e will cause v_e to cross the zero axis and increase beyond point D in the positive direction. If i_e is increased in the negative direction, v_e will increase negatively from B to A. The region from B to C displays negative resistance, while BA and CD represent positive resistance regions. The BA region is termed cutoff, BC negative resistance, and CD saturation.

From the plot in Fig. 214, it is seen that while the emitter current determines the emitter voltage at all points, the emitter voltage does not determine values of emitter current in the same manner. For example; at the marked value of emitter voltage on the graph, emitter current might have either of the values x , y , or z . If the emitter current is *resting* at a lower value, the application of a large transient will flip it to the higher value. Since a higher collector current flows in response to the higher emitter current, this unstable condition of switching to the higher current in response to large signal inputs can cause damage to the transistor unless design precautions are taken to limit the currents.

The transistor normally will be unstable in the region of BC where its emitter-to-base input resistance is negative. However, if the emitter is biased so as to set at the stable point x along the cutoff region BA, the application of a sufficiently large positive pulse will flip conduction to the other stable point z along the saturation region CD. Steady emitter current, corresponding to point z , then will continue to flow even after the pulse is removed. If a strong negative pulse subsequently is applied to the emitter, the current will be flipped back to point x . This ability of the point-contact transistor to exhibit two stable states adapts it to use in flip-flop, switching, and counter circuits. The negative resistance characteristic also enables operation as an oscillator.

The mechanism of negative resistance in transistors is an extensive subject which has received considerable mathematical treatment for detailed analysis. A physical picture of how it is accomplished can be given in comparatively simple terms, however. Both emitter and collector currents flow through the base resistance and have opposite polarities. The net base current is their difference, $i_e - i_c$. In the point-contact transistor with an alpha higher than 1, the negative collector current is by amplification higher than the positive emitter current. The net base current thus becomes negative as long as alpha continues higher than 1, and the voltage drop across the base resistance is $v_b = r_b (-i_c - i_e)$ and is negative. Thus, the base voltage, which appears between base and emitter, can be negative although emitter current is positive. As alpha decreases after the emitter current has reached a certain value, the negative emitter voltage reaches a turning point (C in Fig. 214) after which the positive emitter current then begins to determine the polarity of the net base current and consequently the polarity of v_b and v_e (C to D in Fig. 214).

The foregoing explanation shows that alpha must exceed unity

in order for negative resistance to be evidenced. For this reason, it is easy to see why the property is not encountered in junction transistors (alpha is always less than 1).

The collector circuit also exhibits negative resistance under suitable conditions of currents and voltages, as shown by the curve in Fig. 215. Here, the emitter voltage is held at a constant value while the collector current is varied. The collector voltage first increases negatively from D to C, then decreases from C to B, and finally levels off from B to A. Negative resistance is shown by the region CB. Region DC is cutoff, and BA saturation.

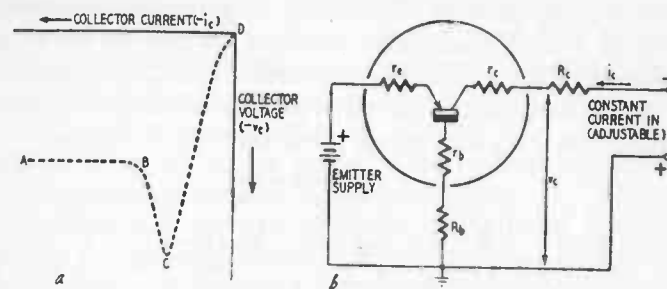

Fig. 215. Curve showing property of negative resistance in collector circuit.

Negative resistance is of concern both as a help and as a hindrance in the application of point-contact transistors: (1) It can be utilized in making flip-flop, switching, counter, and oscillator circuits; (2) uncontrolled, it gives rise to instability in amplifier circuits; and (3) it causes negative input and output impedances. Transistors intended for stable amplifier operation are selected to have a low base resistance in the interest of minimizing tendencies toward negative resistance effects. It is obvious, however, that even a transistor so selected becomes unstable when operated in a circuit with a large-size external base resistor. *Switching-type* transistors are point-contact units selected with high base-resistance values and high alphas, and are intended primarily for use in flip-flop, switching, and counter circuits.

Instability in point-contact transistors is particularly evident when input and output sources and terminations are low-impedance. The units are said to be *short-circuit unstable*. Thus, an amplifier oscillates under such conditions or when connected to low-impedance (constant-voltage) d.c. power supplies. Junction transistors are not short-circuit unstable, since they do not exhibit the negative-resistance characteristics.

Power dissipation

There is a maximum amount of power which can be dissipated by either the emitter or collector without damage to the transistor or a change of its characteristic through heating. Emitter and collector ratings vary with types and manufacture. The permissible emitter dissipation always is lower than the collector dissipation. Typical maximum values are 50 to 150 milliwatts in point-contact types and 30 to 50 mw for junction types.

From a practical standpoint, it is important to note that maximum rated current and voltage do not always coincide with maximum power dissipation in all circuits. A great deal depends upon the effect of a third parameter, such as emitter or base current when collector dissipation is considered. Thus, under circuit operating conditions, maximum rated dissipation might be exceeded long before reaching maximum rated current or voltage.

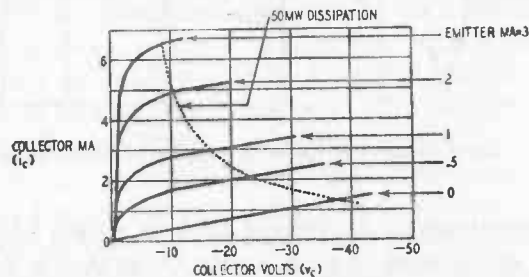

Fig. 216. Collector current vs. collector voltage curves.

Fig. 216 gives a family of collector current vs. collector voltage curves for five constant values of emitter current. A line has been dotted-in to show 50 milliwatts collector dissipation. This line serves to illustrate the fact mentioned in the preceding paragraph. From the curves, note that the 50-mw dissipation is not exceeded at a collector voltage of -30 when the emitter current is zero, but is exceeded at this voltage easily when the emitter current is several or more ma.

Emitter dissipation is seldom listed in tables of transistor operating data. Instead, maximum emitter current is shown. The operator must exercise care to keep within this rating.

Power output

The a.c. output power of a transistor amplifier or oscillator, as in corresponding vacuum-tube circuits, bears a percentage relationship to the d.c. power input supplied to the output electrode.

Thus, in a grounded-base transistor amplifier, the a.c. power output is a fraction of the d.c. collector power input.

Power output of conventional transistors is small by comparison with some small-sized tubes, maximum values being of the order of 25 to 50 mw for point-contact types and 2 to 5 mw for junction types. Up to 10 watts output has been obtained with push-pull class-B amplifiers using junction-type power transistors. Power-type transistors capable of 60-watt operation have been developed in the laboratory. Power transistors for outputs up to 10 watts are available commercially.

From a standpoint of the ratio of a.c. output power to d.c. input power (output efficiency), the junction transistor is a better performer than the vacuum tube, the transistor efficiency being up to 49% for class-A operation and as high as 75% for class-B. All transistors may be considered more efficient than tubes as power converters if over-all power supply requirements are considered, since the transistor requires no filament power.

In grounded-base and grounded-emitter circuits, power output is limited by allowable collector power dissipation. In the grounded-collector circuit, where the emitter is the output electrode, the limiting factor is the maximum allowable emitter power dissipation.

Power gain

The transistor amplifier resembles the class B vacuum-tube amplifier in the respect that each requires a finite amount of signal input power. This is grid-signal power in the tube circuit, and is emitter input or base input in the transistor amplifier.

The over-all power gain (ratio of output-signal power to input-signal power) provided by the transistor depends upon the type of circuit connection employed. Typical values are 18 to 25 db for the high-grade point-contact type in a grounded-base circuit, 30 to 40 db for high-alpha junction types in a grounded-emitter circuit, and 16 to 18 db for high-alpha junction types in a grounded-collector circuit. Transistor power gain varies approximately as the ratio of output to input impedance, and also as the square of alpha.

Noise

Transistor noise level is higher than that of a vacuum tube and increases in importance as the number of cascaded amplifier stages is increased. The noise figure in transistor operating data is specified as so many decibels above thermal noise at 1,000 cycles. Typ-

ical noise-figure values are 65 db for the point-contact type and 22 db for the junction type. Transistor noise decreases with operating frequency. It is higher when produced at the collector than by the emitter.

Frequency response

The upper frequency response of contemporary transistors is a serious limitation to application of these devices. A combination of frequency-dependent factors, such as current amplification, voltage amplification, internal capacitances, transit time, point-contact spacing (close spacing for high-frequency response), spreading of carriers, and equivalent network impedances, act to limit the maximum frequency at which satisfactory operation can be obtained.

In the point-contact transistor, transit time, upon which frequency response depends, varies inversely as the square of the contact spacing. Point-contact transistors made with P-type germanium have somewhat better frequency response than those made

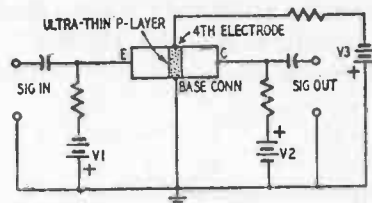

Fig. 217. High-frequency junction tetrode transistor.

with N-type. The reason for this is the higher mobility of electrons which are the carriers in P-type germanium. Holes, the carriers in N-type germanium, travel much more slowly.

The conventional manner of rating transistor frequency response is to specify a *cutoff frequency*, the frequency at which alpha drops to a point 3 db below its low-frequency value. Typical ratings are 2 mc for general-purpose point-contact transistors, 5 to 10 mc for special high-speed point-contact switching units, and 100 kc for junction types. One of the point-contact types (RCA 2N33) is rated for oscillator operation at 50 mc. It is important to note that voltage amplification and power amplification may fall off significantly at some frequency lower than alpha cutoff.

In the junction type, the high-frequency operating limit can be extended by making the central base-region layer extremely thin to reduce transit-time effects. However, this not only increases

manufacturing difficulties but increases the internal base resistance, degrading the performance of the transistor. The N-P-N junction *tetrode* transistor of R. L. Wallace (see Fig. 217) overcomes the effect of high base resistance by means of a negative d.c. bias applied to the central P-layer at a point opposite the base contact. This bias repels the electrons coming from the emitter, forcing them to diffuse through the P-layer near the base connection, instead of all through the layer, thereby reducing the base resistance as much as 10 times.

An interesting practical observation is that all transistors appear able to oscillate at frequencies higher than alpha cutoff.

High-frequency operation up to 70 mc is claimed for the surface barrier transistor developed by Philco. A manufacturing advantage, partly responsible for the higher-frequency operation and accruing from the electrolytic technique (see Chapter 2) is the ability to control the plated-electrode separation in this type of transistor within 10 millionths of an inch.

Temperature effects

The temperature dependence of germanium was stressed in Chapter 1. In the transistor, elevated temperatures act to reduce electrode resistances, decrease amplification, and increase noise. Changes due to temperature appear somewhat more severe in junction transistors than in point-contact units. Operating characteristics usually are specified for 25°C. Typical maximum ambient operating temperature is 50°C. (90°F).

Life

Because of the comparative infancy of the transistor, extensive life data comparable to that available for vacuum tubes and semiconductor diodes have not yet been accumulated. However, tests indicate that life ratings in multiples of 10,000 hours can be expected. Authorities predict a figure of 70,000 hours, which means that a transistor under favorable conditions might operate continuously for 8 years.

Comparison of d. c. requirements

In commercial transistors (depending upon model and manufacture), maximum d.c. collector current ratings vary from 2 to 20 ma for the point-contact type and from 0.5 to 10 ma for the junction types. Maximum d.c. emitter currents vary from 1 to 15 ma for the point-contact types and from 0.5 to 5 ma for the junction types. Maximum d.c. collector voltages vary from 10 to 100 volts

for the point-contact type and from 20 to 50 volts for junction types. Because of developmental work on transistors these figures are by no means inflexible. In fact most of the transistor data presently published is of a tentative nature.

A useful property of the junction transistor is its ability to operate at very low levels of voltage and current. Practical oscillators have been demonstrated to operate on direct current generated by a photocell, a thermocouple, or a pair of coins separated by moistened paper. This property has made possible the design of sub-miniature amplifiers, radio receivers, and hearing aids that may be operated from inexpensive 1½- or 3-volt batteries.

RECOMMENDED READING

1. *Electrons and Holes in Semiconductors*. (Book). William Shockley. (D. van Nostrand Co., Inc.; New York, N. Y., 1950). pp. 27-66, 77-116.
2. *Present Status of Transistor Development*. J. A. Morton. PROCEEDINGS OF THE I.R.E., November 1952. p. 1314.
3. *Fused-Impurity P-N-P Junction Transistors*. John S. Saby. PROCEEDINGS OF THE I.R.E., November 1952. p. 1358.
4. *Variation of Transistor Parameters with Temperature*. Abraham Coblenz and Harry L. Owens. PROCEEDINGS OF THE I.R.E., November 1952. p. 1472.
5. *Transistor Amplifier — Cutoff Frequency*. D. E. Thomas. PROCEEDINGS OF THE I.R.E., November 1952. p. 1481.
6. *Power Rectifiers and Transistors*. R. N. Hall. PROCEEDINGS OF THE I.R.E., November 1952. p. 1512.
7. *RCA Transistors. Form No. SCD-104*. (Booklet). Radio Corporation of America. Tube Department. Harrison, N. J.
8. *Point-Contact and Junction Transistors*. John A. Doremus. RADIO & TELEVISION NEWS (Radio-Electronic Engineering Edition), April 1952. p. 14.
9. *Transistors: A Summary of Progress in Performance*. Anonymous. TELE-TECH, July 1952. p. 36.
10. *A Junction Transistor Tetrode for High-Frequency Use*. R.L. Wallace, Jr. and L. G. Schimpf. PROCEEDINGS OF THE I.R.E., November 1952. p. 1395.
11. *The Surface-Barrier Transistor*. (5 papers). W. E. Bradley, J. W. Tiley, R. A. Williams, J. B. Angell, F. P. Keiper Jr., Robert Kansas, R. F. Schwartz, and J. F. Walsh. PROCEEDINGS OF THE I.R.E., December 1953. pp. 1702-1720.

Chapter 3

Equivalent Circuits

BECAUSE of the vast amount of experience gained with vacuum tubes in electronic circuits and the limited amount of similar experience with transistors, the common tendency is to think of transistors as simply replacing tubes in common circuits. This is not a correct attitude nor a practical one, since there is a basic difference in nature between the control of current carriers in a vacuum and in a solid.

Unlike the vacuum tube, the transistor does not provide isolation between its input and output circuits. Because of this, output conditions in a transistor affect input parameters and vice versa. The transistor resembles a set of connected resistances. It

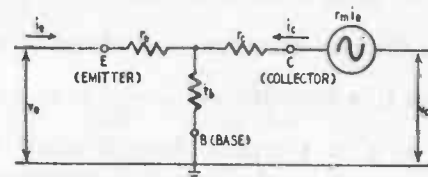

Fig. 301. Equivalent circuit of transistor (grounded-base amplifier at d.c. and low a.f.).

is, in fact, an active resistance network. The successful application of this device to electronic circuits must be based upon its nature as a network.

At d.c. and low audio frequencies, the transistor resembles, and may be described in terms of, a 3-terminal resistance network. This configuration was shown in simplest terms in Chapter 2. We are in a position now to consider the transistor network in

more detail. Transistor circuits may be described also in terms of 4-terminal networks, but we shall restrict our discussion to the 3-terminal variety which serves the purposes of this book.

Network parameters

For the benefit of readers who have no background of network theory, the following definitions of network terms are made with respect to transistor parameters with which they are associated. For reference, Fig. 301 shows the equivalent 3-terminal resistance network of a transistor operating as a grounded-base amplifier. The pure resistive components are allowable for small-signal conditions at d.c. and low audio frequencies. These become impedances, with reactive components, at high frequencies.

Only the transistor impedances are shown. External circuit components, such as load and generator, have been omitted from Fig. 301 for simplicity, but appear in succeeding diagrams.

For the grounded base

(3-1) R_{11} = Input Resistance = slope of the curve v_e vs.

$$i_e \text{ when } i_c \text{ is constant} = \left. \frac{dv_e}{di_e} \right|_{i_c}$$

(3-2) R_{12} = Reverse Transfer Resistance = slope of the

$$\text{curve } v_e \text{ vs. } i_c \text{ when } i_e \text{ is constant} = \left. \frac{dv_e}{di_c} \right|_{i_e}$$

(3-3) R_{21} = Forward Transfer Resistance = slope of the

$$\text{curve } v_c \text{ vs. } i_e \text{ when } i_c \text{ is constant} = \left. \frac{dv_c}{di_e} \right|_{i_c}$$

(3-4) R_{22} = Output Resistance = slope of the curve v_c vs.

$$i_c \text{ when } i_e \text{ is constant} = \left. \frac{dv_c}{di_c} \right|_{i_e}$$

(3-5) $\alpha = a$ = Current Amplification Factor = slope of the curve i_c vs. i_e when v_c is constant =

$$\left. \frac{di_c}{di_e} \right|_{v_c} = R_{21}/R_{22}$$

(3-6) r_m = Active Mutual Characteristic of network = $R_{21} - R_{22} = ar_c$

The output generator in the collector lead in Fig. 301 has a value $r_m i_e$ which corresponds to the generator μE_g in the equivalent circuit of a vacuum-tube voltage amplifier. The active properties of the transistor network are expressed by this generator.

These equations are for the grounded-base amplifier. Simi-

lar equations are used to describe the network characteristics of other circuit configurations; e.g., the grounded-emitter and grounded-collector circuits, as will be shown later. However, certain terms have the same meaning in each circuit. For example; R_{11} is always the input resistance, R_{22} the output resistance, R_{12} reverse transfer resistance, R_{21} forward transfer resistance, and r_m the active mutual resistance.

Grounded-base amplifier

Fig. 302 shows the grounded-base amplifier circuit with its

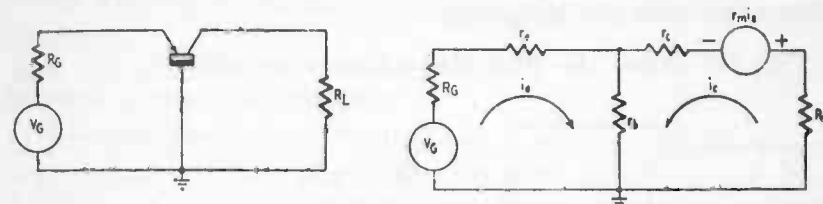

Fig. 302. Grounded-base amplifier and equivalent 3-terminal network.

equivalent 3-terminal network. Bias supplies have been omitted. V_G is the source generator with internal resistance R_G . Component R_L is the load resistance.

(3-7) $r_m = a (r_c + r_b) - r_b$. From Equation (3-6), r_m also = ar_c

$$(3-8) \quad R_{11} = r_e + r_b - \frac{r_b (r_b + r_m)}{R_L + r_c + r_b}$$

$$(3-9) \quad R_{12} = r_b$$

$$(3-10) \quad R_{21} = r_b + r_m$$

$$(3-11) \quad R_{22} = r_c + r_b - \frac{r_b (r_b + r_m)}{R_G + r_e + r_b}$$

Grounded-emitter amplifier

Fig. 303 shows the grounded-emitter amplifier circuit with its

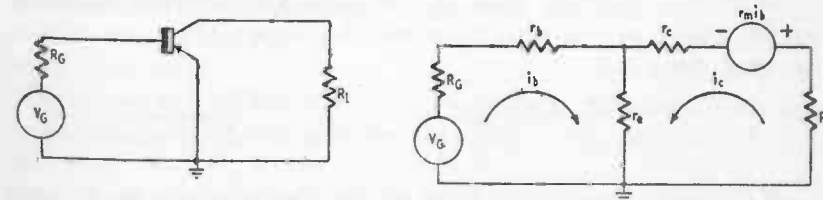

Fig. 303. Grounded-emitter amplifier and its equivalent network.

equivalent network. Note that the output generator here is equal to $r_m i_b$, since the input current is the base current, i_b .

$$(3-12) \quad R_{11} = r_e + r_b + \frac{r_e (r_m - r_e)}{R_L + r_e + r_c - r_m}$$

$$(3-13) \quad R_{12} = r_e$$

$$(3-14) \quad R_{21} = r_e - r_m$$

$$(3-15) \quad R_{22} = r_c + r_e - r_m + \frac{r_e (r_m - r_e)}{R_G + r_b + r_e}$$

Grounded-collector amplifier

Fig. 304 shows the grounded-collector amplifier circuit with

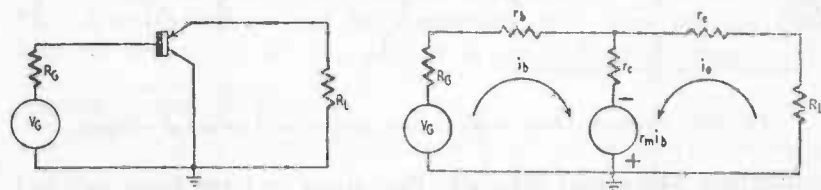

Fig. 304. Grounded-collector amplifier and its equivalent network.

its equivalent network. Here, the emitter is the output electrode and the generator $r_m i_b$ is in the grounded collector.

$$(3-16) \quad R_{11} = r_b + r_c + \frac{r_c (r_m - r_c)}{R_L + r_e + r_c - r_m}$$

$$(3-17) \quad R_{12} = r_c$$

$$(3-18) \quad R_{21} = r_c (1-a)$$

$$(3-19) \quad R_{22} = r_e + r_c - r_m + \frac{r_c (r_m - r_c)}{R_G + r_b + r_e}$$

Power amplification

The operating power gain (G) of transistor amplifier stages is closely related to values of the network components.

Grounded base

$$(3-20) \quad G = 4R_G R_L \left[\frac{-(r_b + r_m)}{(R_G + r_e + r_b)(R_L + r_c + r_b) - r_b (r_b + r_m)} \right]^2$$

For stability, the denominator of the fraction must be greater than zero.

Grounded emitter

$$(3-21) \quad G = 4R_G R_L \left[\frac{r_m - r_e}{(R_G + r_b + r_e)(R_L + r_e + r_c - r_m) + r_e (r_m - r_e)} \right]^2$$

For stability, the denominator of the fraction must be greater than zero.

Grounded collector

$$(3-22) \quad G = 4R_G R_L \left[\frac{-r_c}{(R_G + r_b + r_e)(R_L + r_e + r_c - r_m) + r_c (r_m - r_c)} \right]^2$$

For stability, the denominator of the fraction must be greater than zero.

Reverse power amplification

The grounded-collector *point-contact* amplifier has the attractive property of bilateral amplification when alpha is greater than 1. When $a = 2$, the power gain from output to input is the same

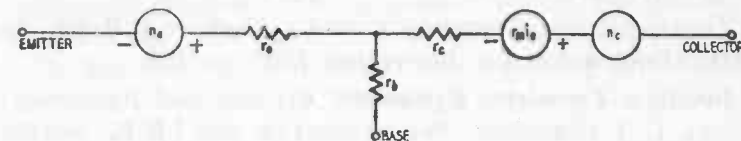

Fig. 305. Equivalent circuit, transistor with noise.

as from input to output. Reverse, or "backward" power gain, G_R , may be expressed in terms of network parameters:

$$(3-23) \quad G_R = 4R_G R_L \left[\frac{-r_c + r_m}{d} \right]^2$$

d is the denominator from equation (3-22).

Reverse power gain may be determined also by multiplying the forward power gain by $(1-a)^2$.

Electrode External Resistances

The terms r_b , r_c , and r_e appearing in the equivalent circuits represent the *total* resistance associated with the base, collector, and emitter electrodes, respectively. This includes any external resistance connected in the leads, as well as the internal resistance determined by v/i . External series resistances occasionally are connected in the leads for purposes of stabilization or feedback. Not included, however, is the output load resistance, which is designated R_L in the network equations and is treated separately from r_b , r_c , and r_e .

Equivalent noise circuit

Fig. 305 is the equivalent circuit of a transistor with emitter and collector noise sources represented by the noise generators n_e and n_c , respectively. The noise generators retain their positions also in the grounded-emitter and grounded-collector amplifier circuits, but the generator r_{mib} changes position as indicated in Fig. 303 and Fig. 304.

RECOMMENDED READING

1. *Equivalent Circuits of Linear Active Four-Terminal Networks*. L. C. Peterson. BELL SYSTEM TECHNICAL JOURNAL, October 1948. p. 593.
2. *Some Circuit Aspects of the Transistor*. R. M. Ryder and R. J. Kircher. BELL SYSTEM TECHNICAL JOURNAL, July 1949. p. 367. *The equations and formulae in the preceding chapter are due to this source.*
3. *Transistors and Transistor Circuits*. Herbert J. Reich. ELECTRICAL MANUFACTURING, November 1952. p. 106.
4. *Junction Transistor Equivalent Circuits and Vacuum-Tube Analogy*. L. J. Giacoletto. PROCEEDINGS OF THE I.R.E., November 1952. p. 1490.

Chapter 4

Transistor Amplifiers

THE basic building blocks of transistor amplifiers are the single-stage grounded-base, grounded-emitter, and grounded-collector circuits. The chart in Table 2 compares the practical operating features of each type of circuit separately for point-contact and junction transistors. This chart has been prepared from

Table 2—COMPARISON OF BASIC TRANSISTOR AMPLIFIERS

Circuit	Transistor Type	Input Resistance (ohms)	Output Resistance (ohms)	Power Gain (db)	Power Output (mw)	Phase Reversal
Grounded-Base	Point-Contact	150-400	6,000-40,000	19-21	30-60	No
	Junction	30-1,000	100,000-500,000	20-29	10-15	No
Grounded-Emitter	Junction	325-1,000	5,000-40,000	30-40	2.8-20	Yes
Grounded-Collector	Junction	150,000-300,000	1,000-20,000	12	—	No

condensed characteristics of transistors available at the time of compilation. The listed values represent the spread shown by the published tentative characteristics. These values are subject to considerable future variation from those listed, since transistor manufacture is by no means fixed at this time.

Which circuit and type of transistor are selected for a given application will depend largely upon desired input and output im-

pedances, power gain, power output, and frequency response. These characteristics are located quickly in Table 2. Input and output parameters are shown as resistances and apply only to low-frequency operating conditions. Power output listings are the maximum values specified by transistor manufacturers.

The chart data are from *typical* operating conditions and are subject to variation under different conditions of application.

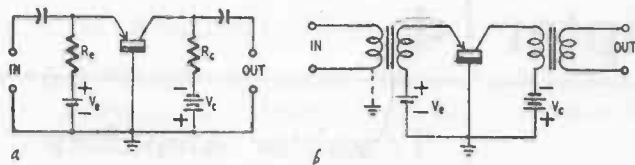

Figs. 401-a, -b. Grounded-base single-stage amplifiers.

The equivalent circuits in Chapter 3 show how input and output resistance and power gain are mutually dependent.

From Table 2 several important aspects of transistor amplifiers are apparent. For example: (1) Only one circuit, the grounded-emitter, reverses the phase of the transmitted signal. (2) The grounded-emitter circuit also provides the highest power gain, although not the greatest power output. (3) Maximum power output is obtained with the point-contact transistor in the grounded-base circuit. (4) The lowest input-resistance values occur in grounded-base circuits. (5) The highest input resistance is provided by the grounded-collector circuit, although this resistance is dependent *directly* upon the value of output (load) resistance used.

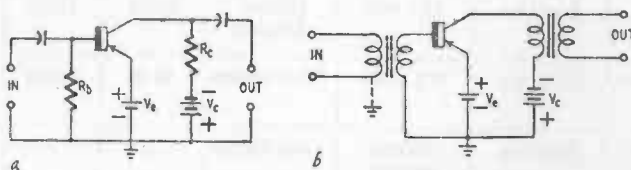

Figs. 402-a, -b. Grounded-emitter single-stage amplifiers.

From a practical viewpoint, junction transistors of both types can be used successfully in any of the three circuits, while point-contact units give good performance only in the grounded-base circuit. While it is possible to operate the point-contact type in the other two circuits, its behavior would be somewhat inferior to that of the junction type because of instability of the contact-

type in those circuits and because of the limited permissible dissipation of the emitter which becomes the output electrode.

Figures 401, 402, and 403 show typical single-stage amplifiers using grounded-base, grounded-emitter, and grounded-collector circuits. In each Figure; "a" designates the r-c coupled version of the circuit, while "b" shows the transformer-coupled version. The battery polarities are correct for N-type point-contact and P-N-P junction transistors. All battery polarities must be reversed for

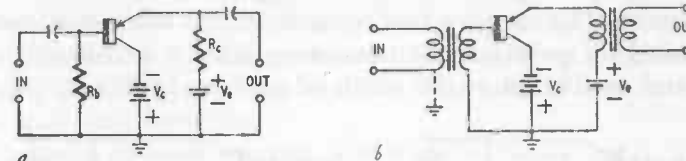

Figs. 403-a, -b. Grounded-collector single stage amplifiers.

N-P-N junction types and P-type point-contact transistors. Otherwise, the circuits are the same.

Single vs. multiple bias supply

In each of the circuits in Figures 401, 402, and 403, separate bias supplies are shown for emitter and collector. While batteries are shown for simplicity, the supplies might also be of the a.c. rectifier type.

The dual supply scheme is not the only practical method of operation. A single battery is sufficient in many applications and often is attractive from a standpoint of economy, simplicity, and compactness. In this connection, it is well to remember that biasing the input as well as the output electrode of a transistor amplifier allows a higher input-signal amplitude to be handled before peak clipping occurs. When use of a single supply means that only the output electrode is biased, only small signals can be handled without distortion. However, any scheme that permits both electrodes to be biased from a single supply widens the range of input-signal amplitudes that can be accommodated. One scheme readily suggesting itself is the use of a center-grounded voltage divider across the single supply, with positive voltage taken from one half for one electrode of the transistor and negative voltage from the other half for the other electrode. This method loses in appeal, however, when the bleeder current greatly exceeds the normal transistor drain.

Fig. 404 shows several typical single-battery amplifier stages.

Fig. 404-a is a grounded-emitter with *floating base* input. This circuit offers somewhat higher input impedance than when the base is biased but can handle only small input signals. In Fig. 404-b, the base is biased through the external resistance R_b . The increased base current due to this bias lowers the input impedance, but large input signals can be handled before peak clipping sets in. Fig. 404-c is a grounded-base circuit in which emitter bias is developed across the external base resistor, R_b . This action is somewhat analogous to self-bias with a cathode resistor in a tube circuit. The use of a base resistor in this manner is not recommended for point-contact transistors, since it encourages instability and oscillation as the result of positive feedback. (See the

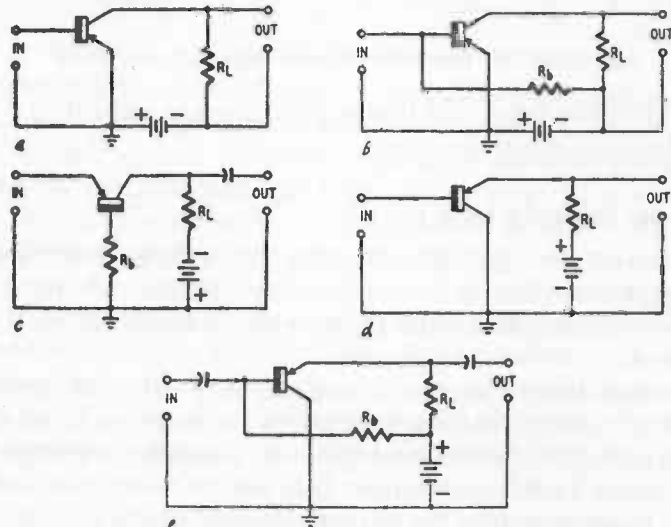

Fig. 404. Typical single-battery amplifier stages.

discussion of *negative resistance* in Chapter 2.) Fig. 404-d and Fig. 404-e show grounded-collector circuits corresponding to the two types of single-battery, grounded-emitter circuit in Fig. 404-a and Fig. 404-b. The remarks already made regarding input impedance and signal level for the floating-base and biased-base grounded-emitter stages also apply to floating-base and biased-base grounded-collectors.

Constant-current requirement

The voltage-operated nature of the vacuum tube conventionalized the low-impedance, constant-voltage power supply. The

transistor favors constant-current d.c. power supplies. We have seen already that the point-contact type, at least, is short-circuit unstable. Its power supply therefore must be *high-impedance*.

The simplest constant-current power supply is a high voltage connected in series with a high resistance. The series resistor should be an order of magnitude higher than the self-resistance of the transistor electrode supplied. In the amplifier circuits in Figs. 401, 402, and 403, the circuit resistances (R_b , R_e , and R_o) in the circuits labeled "a" supply constant current if they and the battery voltages (V_c and V_e) are high enough. In the circuits labeled "b", suitable constant-current resistors must be connected in series with the input and output electrodes if the transistors are short-circuit unstable.

The use of constant-current bias supplies minimizes variations in circuit performance between individual transistors and to some extent, as well, those variations due to temperature, since the large external resistance, rather than the transistor self-resistance, determines the electrode current.

Low-power operation

To the increased operating efficiency of the junction transistor is added its attractive feature of operating satisfactorily at low voltages and currents. Practical amplifiers and oscillators using junction transistors can operate at collector voltages as low as $1\frac{1}{2}$ and 3 volts and at currents of less than 100 microamperes. Experimental oscillators have been operated at a few millivolts of collector potential and a few microamperes of collector current. This ability of the junction transistor to operate at low power levels results in great economy and compactness in portable and sub-miniature electronic equipment. No equal performance is possible with present vacuum tubes.

Input-output coupling

Input and output coupling for a transistor amplifier stage may be of the capacitive, transformer, or direct type. Figs. 401, 402, and 403 give examples of capacitive and transformer input and output coupling, while Figures 404-a, -b, -d show direct coupling. The spread of input and output impedances (resistances) typical of the three types of amplifier stages may be ascertained from Table 2.

Capacitive coupling may be employed successfully when the signal-source impedance is comparable to, or lower than the

transistor input resistance (R_{11}) and when the impedance of the output device is comparable to, or higher than the output impedance (resistance) of the transistor (R_{22}). Thus, a low-impedance dynamic or carbon microphone might be operated directly into the r-c coupled transistor input, while a high-impedance crystal pickup could not. Similarly, an a.c. vacuum-tube voltmeter with its high-impedance characteristic could be driven directly from the r-c coupled output of a transistor stage, while low-impedance headphones could not.

Transformer input and output are required whenever the impedances of the signal source and load device differ significantly from the transistor input and output resistances, respectively, and impedance matching thus is essential.

Direct coupling is employed for d.c. amplification or when coupling components, such as capacitors or transformers, must be omitted from the circuit. In direct coupling also, generator and load impedances must have the proper magnitude relationships to the transistor input and output impedances. That is, the generator impedance must be comparable to, or smaller than the transistor input resistance—and the impedance of the load device must be comparable to, or higher than, the transistor output resistance.

In some applications, it is desirable to connect the load device directly in series with the output electrode of the transistor. Examples of load devices which may be connected in this manner are d.c. meters, high-resistance headphones, d.c. relays, high-impedance loudspeakers, and neon lamps. Such connection is permissible when the steady component of output-electrode current will not interfere with normal operation of the device and when the d.c. resistance of the device is not so high as to reduce significantly the electrode voltage.

Cascading amplifier stages

Transistor amplifier stages can be cascaded, following, in general, the same schemes employed in multistage vacuum-tube amplifiers. Any desirable combination of grounded-base, grounded-emitter, and grounded-collector stages may be cascaded to increase voltage gain or power gain. Noise level is the factor which usually limits the number of stages which can be operated practically.

Cascading transistor amplifier stages is not as easy a matter, however, as building a multistage vacuum-tube amplifier because in every case except the grounded-collector, the transistor input

impedance is lower than the output impedance of a preceding transistor stage. Appreciable power is lost in interstage coupling unless impedance matching is employed. Maximum possible gain per stage therefore cannot be realized in simple r-c coupled cascades such as shown in Fig. 405, although the sacrifice in gain sometimes is justified by the increased simplicity of this arrangement. A rule of the thumb which has arisen in transistor amplifier practice is that at least 1 more stage is required for a given over-all gain with r-c coupling than would be needed if interstage transformer coupling, such as shown in Fig. 406, were used.

From Table 2, it is seen that cascaded, grounded-base, point-contact stages could necessitate working between a 40,000-ohm output and 400-ohm input impedance. This impedance mismatch in r-c coupling would cause such a gain loss that several such stages might be needed to give an over-all gain equal to the total gain of just two transistors. Only by using interstage transformers

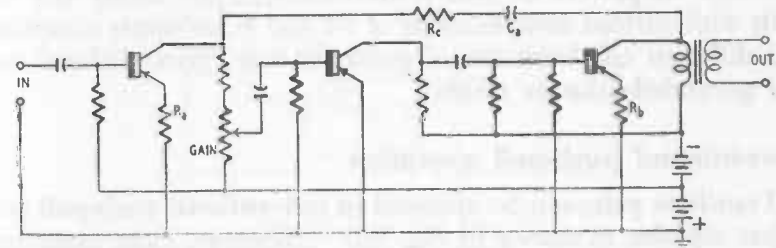

Fig. 405. Resistance-coupled 3-stage transistor amplifier.

to supply the step-down impedance match would cascading these grounded-base transistors be feasible.

Interstage transformers for use between any combination of grounded-base and grounded-emitter stages must provide step-down ratios. Only when working out of any transistor stage into a grounded-collector stage is a step-up ratio required.

The grounded-collector stage is used occasionally as an impedance matcher between two other transistor stages, especially when complete use of r-c coupling is required. In this way, a fair transfer of energy may be obtained between the stages separated by the grounded-collector amplifier. As has been pointed out in earlier chapters, the grounded-collector amplifier will provide fair power gain, but its voltage amplification never can exceed unity. The grounded-collector may be employed as the input stage to give a transistor amplifier relatively high input impedance.

Because the input and output resistances of the transistor in grounded-base and grounded-emitter circuits are relatively low,

the coupling capacitors in Fig. 405 and Fig. 406 must be high in value. For good low-frequency response, these capacitances seldom are under 1 microfarad each and preferably should be 10 to 20 μf . The capacitors (C1 and C2) are required in the transformer-coupled circuit (Fig. 406) to prevent grounding of the base bias through the transformer secondary windings.

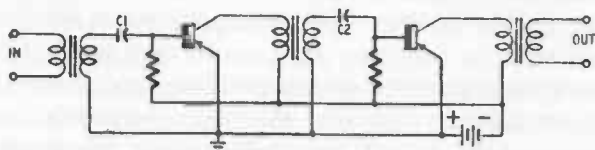

Fig. 406. Transformer-coupled 2-stage amplifier.

While only two typical examples of cascaded-stage transistor amplifiers are shown here, it should be recognized that multistage transistor amplifiers to satisfy individual requirements can be built with various combinations of r-c and transformer coupling and different combinations of grounded-base, grounded-emitter, and grounded-collector stages.

Conventional push-pull operation

Transistor pairs can be operated in conventional push-pull amplifier circuits, as shown in Fig. 407. However, close matching of the transistor characteristics is necessary for efficient push-pull operation with lowest distortion.

Although Fig. 407 shows the grounded-emitter connection in

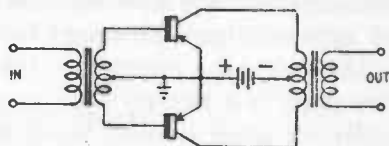

Fig. 407. Conventional push-pull amplifier.

each half of the push-pull circuit, grounded-base and grounded-collector configurations also are useable in push-pull amplifiers.

For input and output impedance matching, the two halves of the circuit may be treated as separate transistor amplifiers. Thus, the upper half of the input transformer secondary matches the impedance of the upper transistor input, while the lower half of the secondary matches the input resistance of the lower transistor. The same applies to the output transformer.

Push-pull by complementary symmetry

Figure 408 shows an ingenious single-ended push-pull amplifier developed by George C. Sziklai of RCA Laboratories, utilizing the complementary symmetry of the characteristics of N-P-N and P-N-P junction transistors. In achieving push-pull operation, this circuit operates from single-ended input and requires neither a phase inverter nor input and output coupling transformers.

Operation is based upon the fact that base-current changes in the same direction in an N-P-N and a P-N-P transistor will cause collector-current changes in opposite directions in the two units. Thus, collector current will rise in one unit and fall in the other. When an input signal is applied to the bases of an N-P-N and a P-N-P transistor in parallel, as in Fig. 408, the transistors deliver amplified output in true push-pull fashion.

On positive half-cycles of the input signal, reduction of the

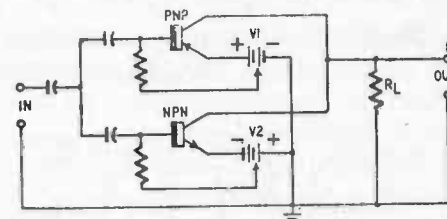

Fig. 408. Push-pull amplifier using complementary symmetry principle.

emitter-collector resistance of the N-P-N unit (due to increased base current in this transistor) causes output terminal 1 to swing negative approaching the potential of the d.c. supply V2. Simultaneously, the positive half-cycle is applied to the P-N-P unit, reducing the base current of the latter transistor and raising its emitter-collector resistance.

On negative half-cycles of the input signal, the base current of the P-N-P unit increases, reducing the emitter-collector resistance of this transistor and causing output terminal 1 to swing positive, approaching the potential of the d.c. supply V1. At the same time, the emitter-collector resistance of the N-P-N unit is increased because of reduced base current in this latter transistor.

In one practical audio application, the high-impedance voice coil of a loudspeaker has been substituted for the load resistor, R_L .

Push-pull class-B operation

The grid bias in a class-B vacuum-tube amplifier always is set for plate-current cutoff in the absence of an input signal. In a

class-B transistor amplifier, emitter bias or base bias may be set to obtain either collector-current cutoff or collector voltage cutoff, under zero-signal conditions.

It usually is more desirable to operate at collector-current cutoff, since the other mode of operation necessitates high collector current drain at zero signal—a condition of low resting efficiency.

Each transistor delivers a single half-cycle of output voltage when driven by the relatively large input signal.

At a given power level, push-pull class-B transistor amplifiers have been found to be more efficient than similar vacuum-tube amplifiers. Output efficiencies in excess of 80 percent have been obtained in the laboratory, with output power from 400 milliwatts to 2 watts in the a.f. spectrum.

Position of gain control

In a transistor amplifier, the gain control must be connected so that minimum disturbance is caused to any impedance match

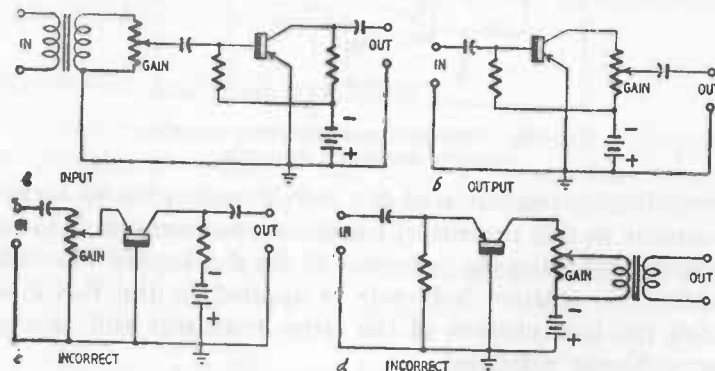

Fig. 409. Positions of the gain control in amplifier circuits.

in the circuit. Some of the conventional positions of gain-control potentiometers in tube circuits therefore would not be satisfactory in transistor circuits.

Fig. 409 shows several possible positions of the gain control. The schemes in Fig. 409-a and Fig. 409-b are satisfactory. The input impedance of the transistor is not altered by settings of the potentiometer in Fig. 409-a nor the output impedance by the control in Fig. 409-b. This is not true of the other two illustrations. In Fig. 409-c, the control setting inserts more or less resistance

between the emitter and base, varying the input impedance of the transistor. In Fig. 409-d the potentiometer settings destroy the match between the collector and the primary of the output transformer.

Negative feedback

Feedback may be introduced into transistor amplifier circuits by methods similar to those employed in tube circuits and comparable advantages may be obtained. Negative feedback is obtainable only in those circuits in which the phase of the transmitted signal is reversed properly. This is an important point when anticipating the application of degeneration since, as was explained earlier, not all transistor circuits reverse the signal phase.

Over-all feedback is secured in the 3-stage transistor amplifier shown in Fig. 405 through capacitor C_a and resistor R_c . Individual-stage feedback is obtained through the medium of the emitter series resistors, R_a and R_b .

A condition to be considered when applying over-all (output-to-input) feedback in transistor amplifiers is the low-impedance input circuit. This is quite different from the condition of extremely high grid-input impedance in vacuum-tube circuits. The low input impedance of the transistor causes some loss of feedback voltage by voltage-divider action or impedance mismatch. The feedback voltage must be taken from a point of sufficiently high potential to compensate for this unavoidable voltage division.

Collector output characteristics

For graphic manipulations, the static collector d.c. characteristics, as displayed by a family of collector voltage vs. collector current curves, may be handled in much the same manner as vacuum-tube E_p-I_p curves.

Fig. 410 shows a family of v_c-i_c transistor curves corresponding to 11 base-current values. These curves are tentative data for the CBS-Hytron type 2N37 P-N-P junction transistor. We have drawn in a 1,000-ohm load line and a collector d.c. dissipation line corresponding to the 50-milliwatt maximum value specified by the manufacturer. Class-A operation is restricted to that portion of the graph where the curve separations are equal (linear operation). Note that all values for the 1,000-ohm load are well inside the 50-mw dissipation range.

The slope of the load line expresses its resistance. $\text{Slope} = dv_c/di_c = (v_1 - v_2) / (i_1 - i_2)$ where v_c is in volts and i_c in amperes. In Fig. 410, this equals $8 - 0 / 0.008 - 0 = 1,000$ ohms. At any point

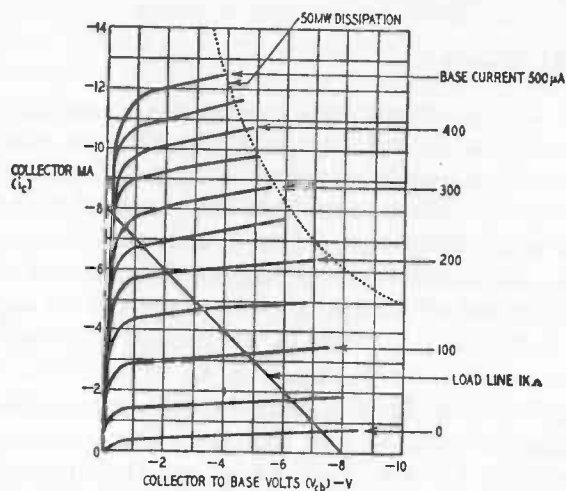

Fig. 410. Family of transistor curves corresponding to 11 base-current values.

along the dissipation line, the product $v_c i_c = 50$ mw. $(V_{cb}) - V$ at the bottom of the graph, Fig. 410, simply means that the abscissae are in minus volts, and that this is particularly collector-to-base volts (V_{cb}) .

Direct-coupled amplifier

Numerous methods are available for direct coupling between cascaded transistor amplifier stages. Fig. 411 shows one system,

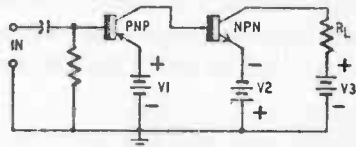

Fig. 411. Direct-coupled amplifier using separate types.

originated by G. C. Sziklai of RCA Laboratories, using a P-N-P transistor followed by an N-P-N unit.

Amplified collector output current of the P-N-P transistor flows through the base-emitter circuit of the N-P-N unit, constituting the signal-input current of the latter. This current then is amplified further by the N-P-N transistor. The first transistor being

directly connected to the second one, the problem of interstage impedance matching is removed. The P-N-P unit receives its negative collector voltage from the N-P-N emitter battery, V2, through the emitter-base path of the N-P-N unit.

By making use of the complementary symmetrical characteristics of the separate types of junction transistors, the batteries all have the proper polarities for correct operation of this direct-coupled arrangement. This would not be possible with transistors all of the same type, when high-gain grounded-emitter circuits are employed in the stages.

Fig. 412 shows a direct-coupled amplifier which allows use of identical transistors in each stage. The arrangement is a grounded-emitter followed by a grounded-base. P-N-P junctions are assumed. Battery V1 has correct polarity for supplying the two emitters, and V2 for the two collectors. This system has

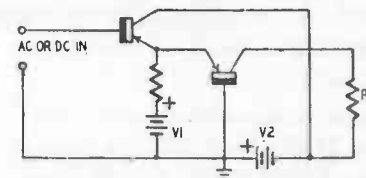

Fig. 412. Direct-coupled amplifier using identical types.

lower overall gain than the one shown in Fig. 411 because of the reduced gain of the grounded-base stage.

Transistors in r.f. amplifiers

The foregoing discussions have concerned mainly a.f. amplifiers. Transistor amplifiers may be operated also at radio frequencies, provided the transistors themselves will reach the frequencies of interest.

The amplifier-type point-contact transistor is the best radio-frequency amplifier. Alpha cutoff for contemporary point-contact units of this type varies from 2 to 5 megacycles, depending upon model and manufacture. Cutoff is the point at which alpha drops 3 db below its 1,000-cycle or 100-kc value, whichever reference point is specified. Voltage-gain cutoff (corresponding to the same 3 db specification) occurs at a lower frequency, often at one-third the frequency of alpha cutoff.

Only sparse data are available on the operating frequency range of junction transistors. Tests indicate that the practical upper frequency limit is between 50 and 100 kc, although occasional

units will provide acceptable amplification up to 500 and 1,000 kc.

Many factors limit transistor frequency range. One is the diffusion time of electrons and holes in the semiconductor. Reactive effects are evident at high frequencies. Collector resistance, emitter resistance, emitter and collector capacitances, a , and r_m show pronounced frequency dependence beyond the audio spectrum. Circuits and operating points also influence frequency range. The upper frequency increases for, example, with collector voltage. In general, the grounded-collector circuit gives the highest frequency response, the grounded-base the lowest, and grounded-emitter an intermediate response. Grounded-emitter bandwidth in junction transistors is improved somewhat when the generator and load resistances are reduced, but this is at the expense of power gain.

Transistor r.f. amplifiers may be operated single-stage, single-ended, push-pull, and in cascade similar to audio amplifiers. Interstage coupling can be capacitive, inductive, transformer-type, and in some cases direct.

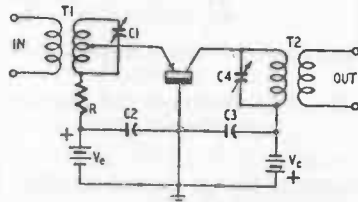

Fig. 413. Single-stage transformer-coupled r.f. amplifier.

At radio frequencies, as at d.c. and low frequencies, the input impedance of the transistor is lower than the output impedance (except in the case of the junction-type transistor used in a grounded collector circuit). The same requirement for a step-down interstage impedance ratio thus holds at radio frequencies. Highest r.f. power gain is obtained through transformer coupling between stages and with transformers at the input and output of a multistage amplifier.

Since point-contact transistors are the best r.f. amplifiers at present and since they operate best in the grounded-base connection, the point-contact grounded-base amplifier circuit is the most widely applied at radio frequencies. Instability is a major factor, however, in the grounded-base operation of point-contact units. But stable operation usually can be obtained when no external resistance is connected to the base. Amplifier-type point-

contact transistors are processed for low internal base resistance (r_b), this parameter usually being held low enough to prevent positive feedback.

Fig. 413 shows a rudimentary type of single-stage transformer-coupled r.f. amplifier. Here, parallel-tuned input and output transformers, T1 and T2, tuned by C1 and C4, have been added to the transistor in the same manner as in a vacuum-tube amplifier. Separate emitter and collector bias supplies (V_c and $V_{c'}$) are shown, but a single supply can be used and the two voltages derived from a voltage divider, as in Fig. 414.

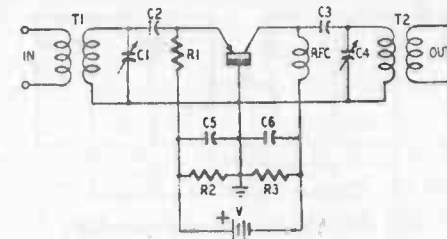

Fig. 414. Transformer-coupled amplifier with shunt feed.

In Fig. 413 the emitter is tapped down the secondary of T1 for impedance matching. The collector also might be tapped down the primary of T2 for the same reason, but usually can be operated as shown. The turns ratios of the two transformers must be correct for matching source and load impedances to the amplifier.

Capacitors C2 and C3 can be of the order of 0.01 to 0.1 μf for intermediate and broadcast-band frequencies, and 0.0001 to 0.005 μf for frequencies between 1.6 and 5 mc. Resistor R keeps the emitter current constant.

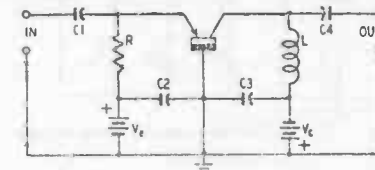

Fig. 415. Impedance-coupled r.f. amplifier.

Fig. 414 is another version of the transformer-coupled amplifier, shunt d.c. feed being used in this circuit. Here, R1 is the constant-current emitter resistor. R2 and R3 represent a grounded center-tapped bleeder across the battery or power supply, a simple method for getting positive and negative voltages from a single

source. C5 and C6 are filter capacitors. Collector current is fed through a radio-frequency choke, RFC, the inductance of which can be a stock value between 1 and 85 millihenries, the lower values being used for the higher radio frequencies and the higher ones for the broadcast and i.f. ranges.

Impedance (choke coil) coupling is employed in untuned and wide-band amplifiers with somewhat better success than straight r-c coupling. An example is shown in Fig. 415. The coupling inductor L is connected in the collector only and can be a high-Q r.f. choke or a specially-designed coil. An inductor also might

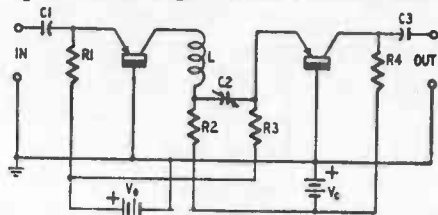

Fig. 416. Series-resonant interstage coupling.

be connected in series with current-stabilizing resistor R and the junction of C1 and the emitter.

Parallel resonant tuned circuits, such as indicated in Fig. 413 and Fig. 414, occasionally encourage instability if the transistor tends toward high a and r_b . The reason for this is that the impedance of the parallel resonant combination drops to low values at frequencies removed from resonance. This might encourage oscillation if the transistor is short-circuit unstable, although the

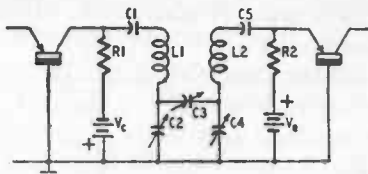

Fig. 417. Double-tuned series-type amplifier.

tuned-circuit impedance is high at its resonant frequency. This difficulty is minimized in the circuit shown in Fig. 416 by the use of a series resonant coupling circuit. The tuned coupling circuit, L-C2, passes maximum current at resonance and works directly into the current-actuated emitter of the second transistor. The r-c coupled output of the second stage may be supplanted by another series LC arrangement for coupling to a third stage.

An extension of this idea is the double-tuned amplifier of Fig. 417 which has tunable series resonant circuits in both emitter and collector of cascaded stages. The collector circuit of the first stage is tuned by L1-C2, and the emitter circuit of the second stage is tuned by L2-C4. Capacitor C3 is for interstage coupling. Coils L1 and L2 are shielded or isolated from each other so as to minimize magnetic coupling. Bias is shunt-fed to emitter and collector through resistors R1 and R2. The blocking capacitors, C1 and C5, are large with respect to tuning capacitors C2 and C4.

The double-tuned amplifier is suited particularly to i.f. amplifiers and similar channels of a fixed-tuned nature. In such cases, capacitors C2, C3, and C4 are screwdriver-adjusted trimmers. This circuit usually is not applied to continuously-tuned r.f. amplifiers because of the prohibitive number of tuning-capacitor gangs required for a multistage arrangement.

Each of the amplifiers shown in Fig. 413 to Fig. 417 may be cascaded with others of the same type, or of the other types shown, for increased gain and, except in the case of Fig. 415, for increased selectivity.

Amplifier characteristics

Current, voltage, and power amplification all are afforded by transistor circuits. Complex formulae for power amplification and for transistor resistances may be found in Chapter 3.

Table 3—APPROXIMATE TRANSISTOR AMPLIFIER FORMULAS

Transistor Amplifier Connection	Input Impedance	Output Impedance	Current Amplification	Voltage Amplification	Power Gain	Vacuum Tube Analogy
Grounded-Emitter	$\frac{r_e + r_b(1-a)}{1-a}$	$r_c(1-a)$	$\frac{-a}{1-a}$	$\frac{-a R_L}{r_e + r_b(1-a)}$	$\frac{a^2 R_L}{[r_e + r_b(1-a)](1-a)}$	Corresponds to cathode grounded amplifier
Grounded-Base	$r_e + r_b(1-a)$	r_c	a	$\frac{a R_L}{r_e + r_b(1-a)}$	$\frac{a^2 R_L}{r_e + r_b(1-a)}$	Corresponds to grounded grid amp.
Grounded-Collector	$\frac{r_b + R_L}{1-a}$	$R_G(1-a)$	$\frac{1}{1-a}$	1	$\frac{1}{1-a}$	Corresponds to grounded plate amp. (cathode follower)

Table, Courtesy Texas Instruments, Inc.

$$\text{Where } a = \frac{r_m}{r_c} \approx \frac{\Delta I_c}{\Delta I_e} \Big] V_e = \alpha$$

Table 3 gives *simplified* formulae for calculating current, voltage, and power amplification, as well as input and output impedances of transistor amplifiers of all three configurations. The symbols in these formulae are the same as those defined in preceding chapters.

RECOMMENDED READING

1. *Transistor Operation: Stabilization of Operating Points*. Richard F. Shea. PROCEEDINGS OF THE I.R.E., November 1952. p. 1435.
2. *Transistor Amplifier — Cutoff Frequency*. D. E. Thomas. PROCEEDINGS OF THE I.R.E., November 1952. p. 1481.
3. *Symmetrical Properties of Transistors and Their Applications*. George C. Sziklai. PROCEEDINGS OF THE I.R.E., June 1953. p. 717.
4. *A Study of Transistor Circuits for Television*. G. C. Sziklai, R. D. Lohman, and G. B. Herzog. PROCEEDINGS OF THE I.R.E., June 1953. p. 708.
5. *Characteristics of the Raytheon PNP Junction Transistors*. (Booklet). F. M. Dukat. Raytheon Manufacturing Co.; Newton, Massachusetts.
6. *Transistor Intermediate Frequency Amplifiers*. (Booklet). J. R. Nelson. Raytheon Manufacturing Co.; Newton, Massachusetts.
7. *Transistorize Your Audio Amplifiers*. Charles W. Martel. RADIO & TELEVISION NEWS, March 1953. p. 40.
8. *The Transistor in Simple Circuits*. William H. Minor, RADIO-ELECTRONIC ENGINEERING, December 1952. p. 14.

Chapter 5

Transistor Oscillators

MOST transistors oscillate readily. We learned in Chapter 2 that precautions often are necessary to *prevent* them from oscillating. Their small size, light weight, and low power requirements suit transistors to many oscillator applications in which their relatively low power output is satisfactory.

Any transistor amplifier can be made to oscillate by feeding a portion of its output energy back to the input circuit in proper phase. In the grounded-base circuit, where there is no phase reversal through the transistor, this often can be done by means of a capacitor connected between the output and input. In the grounded-emitter circuit, inductive feedback coupling may be employed with the transformer windings poled for positive feedback. In the grounded-emitter circuit using a junction transistor, frequency-selective feedback may be obtained through a phase-shifting r-c network.

The negative resistance characteristics of point-contact transistors also may be utilized for oscillation and pulse generation in simple r-c circuits. With the high-alpha point-contact transistor, positive feedback can be developed across a tuned circuit connected in the base-to-ground lead.

This chapter is devoted to practical circuit arrangements for a.f. and r.f. oscillators. The circuit constants correspond to those used in amplifier operation of the same transistor. Iron-cored coils and transformers are employed for audio operation of these circuits, and air-wound units for r.f. operation. It is important to note here that most transistors will oscillate at frequencies

higher than alpha cutoff. High-frequency oscillation is aided by high collector voltages, as long as the maximum rated collector dissipation of the transistor is not exceeded.

In each of the circuits in this chapter, except Fig. 506-b, the bias supply polarities and transistor symbols are for either P-N-P junctions or point-contact units. Opposite polarities for both V_e and V_c apply to the N-P-N junction transistor.

Base-tuned circuit

Fig. 501 shows an oscillator in which the frequency-determining tuned circuit, LC1, is connected between ground and the base of the transistor. Since this circuit depends upon high alpha and to some extent upon emitter negative resistance for its operation, it is satisfactory only for use with point-contact transistors.

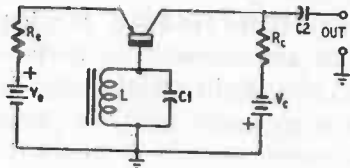

Fig. 501. Base-tuned oscillator.

The collector supply voltage (V_c) and collector load resistance (R_c) have the values which ordinarily would be used for grounded-base amplifier operation of the transistor selected. Values of the emitter supply (V_e) and the emitter current-limiting resistor (R_e) must be chosen for rated emitter current, and R_e must be adjusted carefully for sine-wave output.

Capacitance-coupled collector output is shown. For maximum signal, the impedance of the load device should be at least 10 times the transistor output impedance. Output also may be obtained by inductive coupling to the coil, L. For this purpose, L might be one winding of a transformer and the output coil a second winding. Inductive coupling will allow maximum power output. Where only signal voltage, with negligible power, is required, the collector output connection should be used. This connection has the least detuning effect.

Where practicable, some improvement in operation can be had by tapping the base connection down on coil L for a closer base impedance match. At high frequencies, it will be necessary to bypass both V_e and V_c .

Separate bias supplies are shown, but the two voltages can be obtained from a center-grounded voltage divider in parallel with a single supply.

Oscillators with tickler feedback

Inductively-coupled feedback in a transistor circuit resembles the tickler or single-circuit regenerative scheme found in tube circuits. Fig. 502 illustrates this system. Transformer T is connected between output and input to feed back a portion of the output-signal energy to the input circuit, the windings being poled for positive feedback.

Fig. 502-a shows a grounded-base arrangement, while Fig. 502-b is a grounded-emitter version of the circuit. The latter is recommended for junction-type transistors only. The grounded-base may be used with any type. Because of the higher gain of the

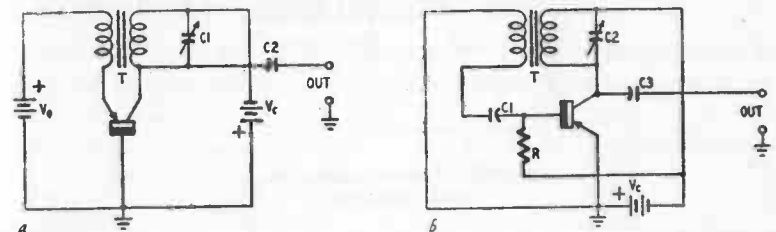

Figs. 502-a, -b. Grounded-base and grounded-emitter tickler-type oscillators.

grounded-emitter circuit; the arrangement in Fig. 502-b will oscillate the more readily of the two circuits when low-alpha units must be used.

The transformer T should have a step-down ratio from collector to input for correct impedance matching. The collector winding is shown tuned to the desired oscillation frequency by the capacitor, C1 in Fig. 502-a and C2 in Fig. 502-b. However, in some cases, it may be desirable to tune the other winding. In Fig. 502-b, the emitter coupling capacitor, C1, must be large enough in capacitance to prevent tuning the base winding of the transformer.

The two bias supplies, V_e and V_c in Fig. 502-a may be supplanted with a single supply. Emitter and collector voltages then would be derived from taps on a center-grounded voltage divider shunting the supply.

Capacitance-coupled, high-impedance output is shown for both circuits. Output also can be taken from a third winding on

transformer T and this winding can be proportioned for proper impedance match to the load service.

If the d.c. resistance of the transformer windings is high, the voltages V_e and V_c of the two bias supplies must be increased proportionately to obtain rated transistor electrode voltages. Emitter current must be adjusted closely by variation of a series resistor to obtain sine-wave signal output. In Fig. 502-b, the base resistor R may be adjusted for this same purpose. When V_e or R is too low, peak clipping will take place and in extreme cases the circuit will behave like a blocking oscillator.

Series-resonant feedback

There is some objection to the conventional inductive feedback arrangements shown in Fig. 502, although these circuits will work with most transistors. The reason for this is the debatable

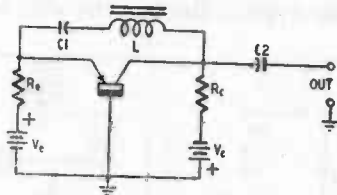

Fig. 503. Series-resonant feedback oscillator.

practice of shunting the high-impedance voltage-supplying parallel resonant circuit with the low-impedance collector or emitter.

A more logical approach would appear to be use of a low-impedance current-supplying series resonant circuit in the feedback path. Fig. 503 shows an oscillator employing this type of feedback. At resonance, the tuned feedback loop, LC1, has its lowest impedance, hence highest feedback current is supplied to the emitter. This type of feedback can be used only in the grounded-base circuit when applied in the manner shown in Fig. 503. Point-contact and junction transistors both are satisfactory.

The phase of the transmitted signal is rotated 180 degrees by the single-stage grounded-emitter circuit, so two cascaded grounded-emitter stages would be needed to obtain feedback voltage of the correct phase for oscillation. In most instances, the added expense and complication fail to justify the extra transistor stage.

The oscillation frequency is determined principally by the values of L and C1, although emitter and collector currents

have strong influence. The values of V_e , V_c , R_e , and R_c are the same as required for amplifier operation with the chosen transistor. Emitter current must be adjusted, by variation of R_e , V_e , or both, for sine-wave output.

Two d.c. bias sources are shown, but a single source may be employed and the emitter and collector voltages taken from taps properly spaced on the center-grounded voltage divider. The emitter supply, V_e , may be omitted entirely. However, when this is done, peak clipping and resulting high distortion of the output signal occurs at lower output levels than when fixed bias is provided.

Capacitively-coupled high-impedance output is shown and is the most practical for this type of oscillator. Light loading will have negligible detuning and distorting effect.

Inductively-coupled series-resonant feedback

The circuits in Fig. 504 allow some of the advantages of both inductive output-input coupling and series-resonant tuning to be

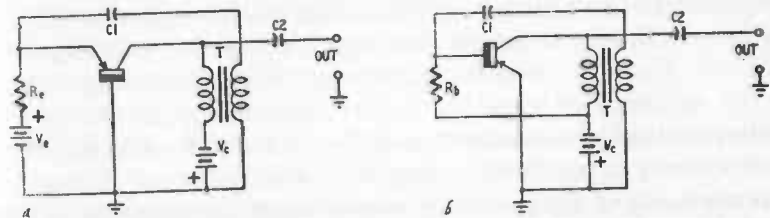

Figs. 504-a, -b. Transformer feedback in grounded-base and grounded-emitter circuits with series-tuned secondary.

secured. Transformer T provides inductive coupling from the collector output. The secondary winding of this transformer forms a series-resonant circuit with the capacitor C1 connected back to the input. The oscillation frequency is determined principally by the secondary inductance and the C1 capacitance. The transformer must have a step-down ratio, from collector to input, for impedance matching in the chosen transistor.

The grounded-base circuit (Fig. 504-a) is suitable for either point-contact or junction transistors, but the grounded-emitter circuit (Fig. 504-b) is for junction types only. Capacitive high-impedance output coupling is shown, and with high-impedance external loads will have the least detuning effect. Output also may be taken from a third winding on the transformer and this winding can be proportioned for exact match to the external

load impedance. This latter connection permits maximum power to be drawn from the oscillator but has the greatest detuning effect.

Low-distortion sine-wave output may be obtained by adjustment of R_e , V_e , or both (Fig. 504-a) and by adjustment of R_b in Fig. 504-b.

R-C type oscillators

The simplicity and compactness of resistance-capacitance type circuits is as attractive in transistor oscillators as in similar tube circuits. However, not every tube-type r-c oscillator can be transistorized readily.

Fig. 505 shows three practical r-c type transistor oscillator circuits. The arrangements in Fig. 505-a and Fig. 505-b are for point-contact transistors only, while the one in Fig. 505-c is for junction units only.

The circuit in Fig. 505-a is used frequently as a pulse generator or multivibrator. Switch-type point-contact transistors are especially suited to this circuit. With a high-alpha unit, appreciable positive feedback voltage is developed across the external base resistance, R_b . The oscillation frequency is determined by capacitor $C1$, resistance R_e , and the input resistance of the transistor. Emitter and collector currents and the value of R_b also influence the frequency at any fixed setting of $C1$ and R_e .

As the value of R_e is varied, the oscillation frequency will jump abruptly from one discrete value to another, in the familiar manner of a multivibrator. With large values of feedback, the output waveform consists of steep unilateral pulses. At low feedback levels, the output waveform becomes more rounded and bilateral, nearly sinusoidal at very low values.

The external collector resistance, R_e , has the same value it would have in an amplifier or switching circuit employing the same transistor. The base resistor, R_b , will be between 100 and 2,000 ohms, depending upon the model and manufacturer of the transistor.

The oscillator may be synchronized readily with a signal which is capacitance-coupled between emitter and ground, or base and ground.

Capacitance-coupled high-impedance output is shown. Output may be taken also at lower impedance capacitively from across base resistor R_b . A very high impedance load device is necessary

to prevent detuning the oscillator or degrading its output waveform.

The circuit shown in Fig. 505-b is a simple grounded-base amplifier with external base resistance, R_b . Positive feedback is developed across R_b . Capacitor $C1$ also provides capacitive feedback coupling between collector and emitter. In some instances,

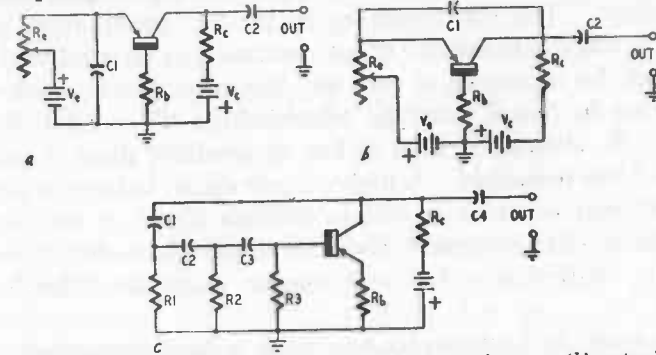

Fig. 505. R-C type oscillators. (a) negative resistance, (b) capacitive feedback, (c) phase-shift.

R_b may be omitted—the base being grounded directly. Like the circuit shown in Fig. 505-a, this arrangement is satisfactory only for use with point-contact transistors.

The oscillation frequency is determined principally by the values of $C1$, R_e , and the input resistance of the transistor, although it is sensitive also to emitter and collector current levels and to the value of R_b . For any given setting of the resistances and currents, the frequency is inversely proportional to the value of $C1$.

The external collector resistance, R_e , is the same value that would be used in a grounded-base amplifier or switching circuit employing the same transistor. Emitter current may be set, by means of adjustments of R_e or V_e , for shaping of the output wave. The output waveform will vary from steep unilateral pulses for heavy feedback to nearly sinusoidal for light feedback.

Capacitively-coupled high-impedance output is shown, but lower-impedance output can be obtained capacitively across the base resistor, R_b . High-impedance load devices must be employed to prevent detuning and waveform deformation.

A phase-shift oscillator circuit is shown in Fig. 505-c. Here, a grounded-emitter arrangement is used with a junction transistor. The grounded emitter resistor, R_b , provides stabilization through degeneration.

The feedback network is composed of three cascaded sections (C1-R1, C2-R2, and C3-R3) which provide 180 degrees of total phase shift between the collector output and base input. Each section provides 60 degrees shift. The problem of a phase-shift network for a transistor is somewhat more complicated than one for a vacuum tube, chiefly because of the low input impedance of the transistor. The last resistance in the r-c combination is not simply R3, but the transistor input resistance in parallel with R3. In terms of the resistance of each leg, the capacitance required in that leg may be found from the relationship: $C = 0.578/6.28R$.

Resistor R_b should be kept as low as possible, since it reduces the gain of the transistor. A high output signal voltage is needed at the collector in order to obtain enough signal at the base of the transistor, after successive divisions in the phase-shift network, to sustain oscillation. For this reason, high amplification is required.

The output is high-impedance, and a high-impedance load device must be used for minimum loading, detuning, and waveform deformation. Stability and positive action of the oscillator may be improved by using 3 cascaded grounded-emitter amplifier stages in place of the single stage shown. This will provide higher amplification before feedback. The odd number of stages is required for proper phasing.

Under proper operating conditions of base and collector currents, good output waveform can be obtained. Resistance R_b may be adjusted for the best compromise between quick starting, good waveform, and output signal amplitude.

Crystal oscillators

Quartz crystals may be connected into transistor oscillators in a variety of ways. Fig. 506-a shows one method in which the crystal is connected between emitter and base of a point-contact transistor, and the tuned circuit, L-C1, operated between base and ground. This circuit is covered by U.S. Patent No. 2,570,436 issued to Everett Eberhard and Richard O. Endres and assigned to Radio Corporation of America.

Emitter bias is adjusted by means of potentiometer R1. The parallel resonant circuit, L-C1, is tuned to the crystal frequency. The external collector resistance, R_c, is adjusted for normal collector current with the 22½-volt bias source, V_c.

Capacitively-coupled high-impedance output is shown. Output also may be obtained by inductive coupling to coil L. This

type of coupling will allow the most power to be drawn from the circuit.

Fig. 506-b shows a crystal-controlled 100-kc standard frequency oscillator developed at the National Bureau of Standards. This unit, employing an N-P-N junction transistor, operates with such economy that it can be left running continuously. This is a

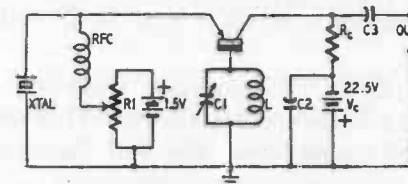

a XTAL AT EMITTER IN

Fig. 506-a. Crystal at emitter-input.

decided advantage with standard frequency oscillators since continuous operation eliminates frequency drift and lost time due to warmup periods after switching on. The oscillator draws 100 microamperes d.c. from the single 1.35-volt mercury cell and is estimated to run continuously for 5 or more years before the battery must be replaced.

Tests at the Bureau of Standards show this oscillator to have a long-term drift of only 3 parts in 10⁹ per day at 100 kc. Its short-term stability is 3 parts in 10¹⁰. The frequency varies approximately 1 part in 10⁸ per degree Centigrade temperature change, and 1 part in 10⁸ per 0.10-volt supply-voltage variation.

The N-P-N transistor is used in the grounded-emitter connection. A capacitive voltage divider (C3 and C4 in series) reduces

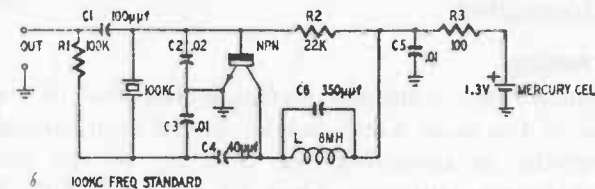

6 100KC FREQ STANDARD

Fig. 506-b. Standard frequency oscillator. (Courtesy, Nat'l. Bureau of Standards).

the r.f. signal voltage from the tuned circuit (L-C6) before it is applied to the crystal. An output of 0.8 volt is provided by the oscillator.

High-frequency oscillator

The upper frequency limit of an oscillator using a conventional transistor follows somewhat the frequency characteristics of the

transistor as an amplifier. However, it is well known that transistors will oscillate at frequencies beyond alpha cutoff, especially if higher collector voltages are used without exceeding maximum allowable collector dissipation.

Conventional point-contact transistors have been made to oscillate up to 2 to 10 mc. Junction transistors will reach 200 to 500 kc with individual units oscillating occasionally at 1 to 1.8 mc. Laboratory transistors of both types have oscillated at still higher frequencies.

The RCA type 2N33 point-contact transistor is a high-frequency oscillator available commercially. This unit oscillates at frequencies up to 50 megacycles. Fig. 507 shows the circuit of a

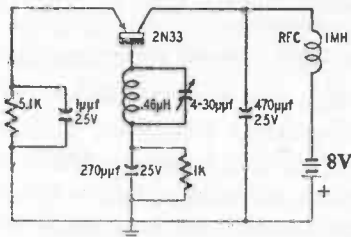

Fig. 507. High-frequency oscillator for use at 50 mc. (By permission of RCA, copyright proprietor).

50-mc oscillator using the 2N33. R.f. output may be taken from the circuit by coupling inductively to the tank coil, L1.

An oscillator of this type was used at amateur station K2AH to establish the first recorded amateur 2-way contact using a transistor-type transmitter.

Oscillator tuning

The frequency of a transistor oscillator, like that of a vacuum-tube circuit of the same kind, can be varied continuously or in steps by varying or switching one or more of the frequency-determining circuit constants. Thus, in Figs. 501, 502, 503, and 504, the frequency-determining capacitor may be switched in value in audio oscillators, or a variable capacitor can be used at radio frequencies. The associated coil or transformer winding may be switched in value to change ranges when the capacitor is variable.

It will be more convenient in Fig. 505-a and Fig. 505-b to vary or change the value of resistor R_e to change frequency, and to change or switch capacitor C1 to change range. In the phase-shift oscillator (Fig. 505-c, all three network capacitors (C1, C2,

and C3) must be varied simultaneously, or all three network resistors (R_1 , R_2 , and R_3) simultaneously, in order to change frequency.

RECOMMENDED READING

1. *Experimental Circuits for Crystal Triodes*. Rufus P. Turner. RADIO-ELECTRONICS, June 1950. p. 66.
2. *Transistor Oscillators with Crystal Control*. Nathaniel Rhita. RADIO-ELECTRONICS, April 1952. p. 56.
3. *Point-Contact and Junction Transistors*. John A. Doremus. RADIO-ELECTRONIC ENGINEERING, April 1952. p. 14.
4. *Transistor A. F. Oscillator*. F. W. Lehan. ELECTRONICS, August 1949. p. 90.
5. *Low-Drain Transistor Audio Oscillator*. D. E. Thomas. PROCEEDINGS OF THE I.R.E., November 1952. p. 1385.
6. *Pulse Duration and Repetition Rate of a Transistor Multivibrator*. G. E. McDuffie, Jr. PROCEEDINGS OF THE I.R.E., November 1952. p. 1487.

Chapter 6

Duality in Transistor-Circuit Design

In electrical engineering, one component or circuit is said to be the *dual* of another component or circuit when current in one behaves like voltage in the other. Thus, inductance is the dual

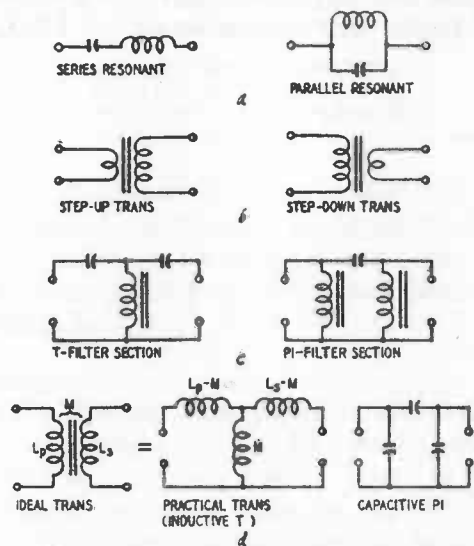

Fig. 601. Circuit elements with duals.

of capacitance, current of voltage, parallel of series, impedance of admittance, open circuit of short circuit, etc. The reverse also is true. For example, if resistance is the dual of conductance, then conductance is the dual of resistance. Very important to the present study, the transistor is considered to be the dual of the vacuum tube.

Table 4 lists several common components, properties, and circuits with their duals. The table may be read across in both directions. Thus, line 8 is read either "node is the dual of loop," or "loop is the dual of node."

On the basis of current and voltage behavior, many duals in electronic circuitry will suggest themselves to the reader: A

Table 4—COMMON COMPONENTS, PROPERTIES, AND CIRCUITS WITH THEIR DUALS

Item	Dual
1. Resistance (R)	Conductance (G)
2. Inductance (L)	Capacitance (C)
3. Impedance (Z)	Admittance (Y)
4. Voltage (E, V)	Current (I)
5. Tube	Transistor
6. Plate current (I_p)	Collector voltage (v_c)
7. Plate voltage (E_p)	Collector current (i_c)
8. Node	Loop
9. Series	Parallel
10. Step-up transformer	Step-down transformer
11. Parallel capacitance	Series inductance
12. Inductive "T"	Capacitive "pi"
13. Voltage supply	Current supply

series-resonant circuit is the dual of a parallel-resonant circuit, a shunt bypass capacitor is the dual of a series choke coil, and the dual of a current through a capacitor is a voltage across a coil.

Fig. 601-a and -b shows some simple circuit elements and circuits with their duals. The dual of a voltage step-up transformer is a current step-down transformer. In Fig. 601-c note that each series capacitor in the T-section is replaced by a shunt inductor in the pi-section dual, and the shunt inductor in the T-section by a series capacitor in the pi-section. Coupled coils in a circuit with mutual inductance presents an interesting case illustrated by the transformer in Fig. 601-d. The transformer is represented by an inductive T-network when its mutual inductance, M , is less than either the primary inductance (L_p) or the secondary inductance (L_s). The dual of this inductive T is the capacitive pi. (See item 11 in Table 4).

Applications to transistor circuit design

Duality is a useful tool for converting well-known vacuum-tube circuits into transistor circuits. Briefly, the technique is to put circuit elements with current characteristics in place of the tube-circuit elements which have corresponding voltage characteristics. While not every situation can be handled completely by

Table 5—DUALS IN TERMS OF TRANSFORMATION RESISTANCE

Tube-Circuit Quantity	Transistor-Circuit Dual	Value of Dual
R	G	$R/r_1 r_2$
i	e	$i r_2$
e	i	e/r_1
L	C	$L/r_1 r_2$
Z	Y	$Z/r_1 r_2$
e_p	$-i_c$	e_p/r_1
i_p	$-e_c$	$i_p r_2$
e_g	$-i_e$	e_g/r_1^*
i_g	$-e_e$	$i_g r_2^*$
r_p	r_c	$r_1 r_2/r_p$
μ	a	μ
G_m	r_m	$G_m r_1 r_2$

*For grounded-base connection

duality, this process is applicable to a number of transformations from tube circuits to transistor circuits.

In Fig. 213, Chapter 2, the duality between transistor and tube characteristics may be seen. The families of transistor collector voltage vs. collector current correspond to several constant emitter or base current values, while the dual plate current vs. plate voltage family of curves corresponds to several constant grid voltage values.

A simple re-drawing of a tube circuit with transistor in place of tube and with substitutions of voltage-operated circuit elements

for current-operated elements, and vice versa, will give a pictorial view of the new circuit configuration. The quantitative work in determining circuit-component values and exact configurations is not so simple, however. The procedure is to write first a complete set of Kirchhoff's equations expressing completely the current and voltage relations in the tube circuit which is to be transformed. Next, voltages are replaced with currents, and currents with voltages in every part of the equations. Also, each symbol must be superseded by the symbol of the dual quantity. Finally, the circuit is redrawn from the transformed equations, and is the configuration for use with the transistor. The transistor circuit itself becomes the dual of the tube circuit and should perform more efficiently than when the transistor simply is substituted for a tube in a conventional tube circuit.

A convenient device for use in duality calculations between a given tube circuit and a desired transistor circuit is *transformation resistance* (r). The quantity r consists of two parts, r_1 and r_2 , so related that $r_1 r_2 = r_p r_c$, where r_p is the tube plate resistance and r_c the transistor collector resistance. Both r_1 and r_2 may be chosen at will. As an illustration of the use of the transformation resistance, a series inductor (L) in the tube circuit is replaced in the transistor circuit by a shunt capacitor (C) with a value of $L/r_1 r_2$. Table 5 shows several tube-circuit constants with corresponding transistor-circuit duals and the relationship of the latter to the former in terms of transformation resistance.

Examples of dual circuits

Fig. 602 shows three simple examples of common tube circuits and the corresponding transistor dual circuits. In Fig. 602-a, a double-tuned vacuum-tube amplifier (of the type commonly found in receiver i.f. stages) has the plate of the first tube tuned by parallel-resonant circuit L1-C1, and the grid of the second tube tuned by a similar parallel-resonant circuit, L2-C2. The two coils are inductively coupled by mutual inductance M . In the dual transistor circuit, the plate parallel-resonant circuit of the tube amplifier becomes the series-resonant circuit, L3-C3. Likewise, the grid parallel-resonant circuit in the tube amplifier becomes the series-resonant circuit L4-C5 in the transistor amplifier. Mutual inductance M is replaced by the capacitive coupling C4.

A plate detector is shown in Fig. 602-b. It is customary to operate a low-pass pi-section filter, such as L1-C2-C3, in the plate

output circuit of such a detector. The series capacitor, C1, in the tube circuit becomes the shunt inductor, L2, in the transistor circuit. Shunt capacitors C2 and C3 become the series inductors, L3 and L4, and the series inductor, L1, becomes the shunt capacitor, C4. In the tube circuit, grid voltage E_g is applied to the tube through a series resistor, R1. This voltage source is across the grid-input circuit of the tube. In the corresponding transistor circuit, the voltage supply-in-series-with-a-resistor is replaced with a current supply, I_g , shunted by a conductance, G. The curved arrow is the standard symbol for a current supply. Note that the transistor current supply, unlike the tube voltage supply, is in series with the input. In performing the transformation to dual circuits, all voltage supplies in the tube circuit are replaced by current supplies in the corresponding transistor circuit.

Fig. 602-c shows a single-tuned impedance-coupled amplifier. This type of connection is found in the stages of some i.f. strips and in the exciter and r.f. amplifier stages of radio transmitters. In the corresponding transistor circuit, L1-C1, the parallel-resonant circuit of the tube amplifier, is replaced by the series-resonant circuit, L2-C3. Series capacitor C2 becomes the shunt inductor, L3. Shunt resistor R1 becomes the series conductance, R2. T is an ideal phase-reversing transformer inserted here because the grounded-base transistor does not reverse phase. Its purpose is to provide the same phase shift introduced by the tube in the original circuit. It may be omitted when signal phase is of no consequence. In each example except the tube circuit in Fig. 602-b all d.c. supplies have been omitted for the sake of simplicity in the diagrams.

Practical Limitations

Application of the principle of duality will, in many instances, yield a transistor circuit which will perform the functions of a tube circuit more efficiently than if the transistor and its bias supplies simply were substituted for the tube and its supplies in the original circuit. However, there are some cases where the best type of circuit will not be obtained by dualizing a known tube circuit, but only by designing a specific transistor circuit from the start.

For one matter, the assumption of duality between the transistor and tube, except for the fact that the former is current-actuated and the latter voltage-actuated, assumes that both devices have similar dissipations and that the μ of the tube equals

alpha of the transistor. This cannot be true of modern tubes, since the alphas in contemporary transistors available commercially average 2 to 3.

Specific functions of some components in the tube circuit must be considered before attempting to dualize these components in the transistor circuit. For example, a series capacitor might have been included between stages in a tube circuit solely for the

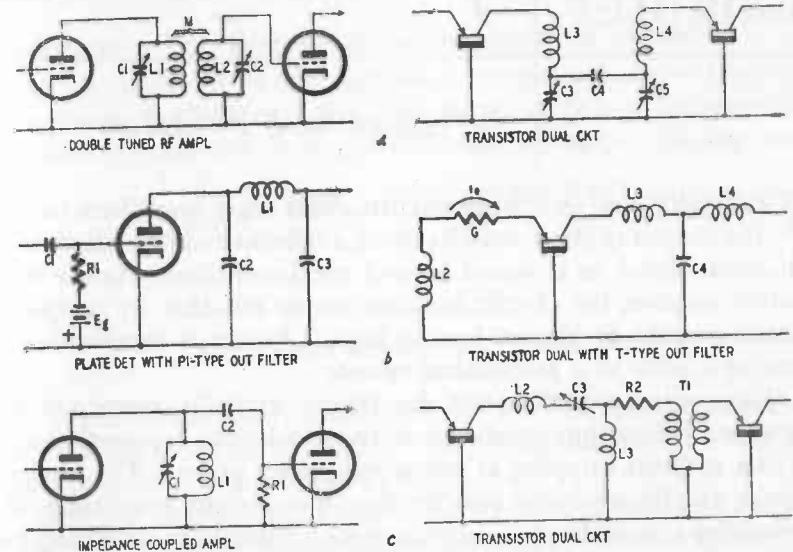

Fig. 602. Representative tube circuits with transistor duals.

purpose of d.c. blocking. If this component were dualized as a shunt inductor in the transistor circuit, the emitter of one stage might be subjected to the high collector voltage of a preceding stage. It would appear that the inductor appropriately would become the secondary of a current transformer coupling the transistor stages.

RECOMMENDED READING

1. *Duality as a Guide in Transistor Circuit Design*. R. L. Wallace and G. Raisbeck. BELL SYSTEM TECHNICAL JOURNAL, April 1951. p. 381.
2. *Transistor Circuit Design*. Gordon Raisbeck. ELECTRONICS, December 1951. p. 128.
3. *New Transistor Circuit Design Method*. I. Queen. RADIO-ELECTRONICS, October 1951. p. 64.
4. *Recent Developments in Transistors*. AEROVOX RESEARCH WORKER, October-November 1952. Aerovox Corp., New Bedford, Mass.

Chapter 7

Triggers and Switches

TRIGGER and switching circuits differ from amplifiers in that the output of these circuits is not a continuous reproduction of an input signal, as it would be in a good amplifier. As the term *switch* implies, the circuit is either on or off—that is; output is either present or absent, low or high. Action is comparable to that of a relay or a mechanical switch.

The control signal, called the *trigger or pulse*, snaps the circuit into full-output condition or back to low-or zero-output condition without stopping at any intermediate point. The control-signal amplitude being smaller than the output amplitude, the switching circuit has power sensitivity. Electronic switching circuits, of which the vacuum-tube flip-flop is a familiar example, are highly desirable because they can switch back and forth at speeds greatly exceeding those possible with the fastest electromechanical devices like relays. In high-speed computers, for example, electronic switching circuits often operate at a 1-megacycle rate (switching time of 1 microsecond).

The transistor offers considerable attraction as a switching device, particularly in complicated machines like counters and computers where many such circuits are needed, because of its small size, low power requirements, cool operation, and long life. As in other areas of transistor application, however, numerous problems such as uniformity of characteristics, drift, temperature dependence, transit time, etc., are to be solved before large-scale use will be practicable. The transistor switching circuit, like its vacuum-tube counterpart, offers noteworthy improvements over electromechanical switching devices.

A considerable amount of work on transistor switching circuits already has been done in many laboratories, especially at Bell

Telephone Laboratories, and much experience has been gained. Practical circuits resulting from this research and development take many forms, but most of them depend upon the negative-resistance characteristic of point-contact transistors. The broad subject of transistor switching circuits has so many ramifications that its full, detailed coverage is beyond the scope of this book. This chapter describes the basic action of these switching circuits.

Switching action through transistor negative resistance

In continuation of the discussion introduced under *Negative Resistance* in Chapter 2, Fig. 701 shows an N-type point-contact transistor connected in a grounded-base circuit to display emit-

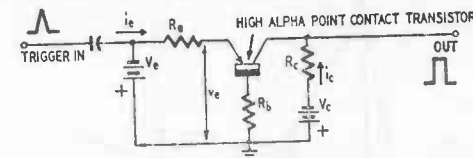

Fig. 701. Basic switching circuit using emitter negative resistance.

ter negative-resistance characteristics. The current amplification factor, alpha, of this transistor must be higher than 1, hence the restriction to the point-contact type.

External resistors, R_e , R_b , and R_c , are connected to the emitter, base, and collector electrodes, respectively. When emitter current, i_e , is varied continuously, emitter voltage v_e , describes a plot

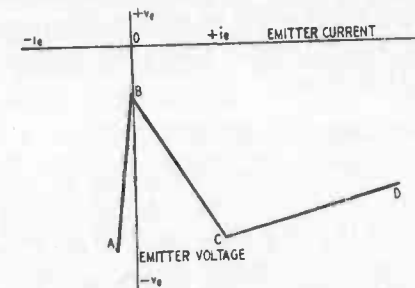

Fig. 702. Emitter negative-resistance curve.

such as shown in Fig. 702. The region AB, when emitter current is negative, shows a small current excursion for a rather large voltage change and for obvious reasons is termed *cutoff*. This is not a true cutoff condition in the sense that we are accustomed to use the term in vacuum-tube practice, but one representing a current flow small enough to justify the term. Region AB rep-

resents a positive resistance. The voltage change in region BC is reversed with respect to the direction of emitter-current change, hence denotes negative resistance. The third region, CD, in which the emitter voltage change is slight for a rather large increase in emitter current, is termed *saturation* and represents a positive resistance.

Thus, there are three discrete regions, AB, BC, and CD, in the v_e versus i_e characteristic, with an *upper turning point* (B), *lower turning point* (C), and two positive-resistance regions separated

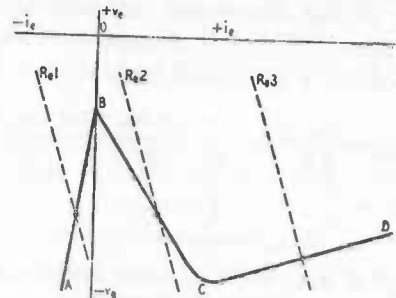

Fig. 703. Emitter negative-resistance characteristic with single operating points.

by a negative-resistance region. Although the entire characteristic is nonlinear, each of its three regions conveniently may be considered separately as linear for purposes of analysis.

The transistor will be unstable when the values of R_e and v_e are such that the operating point is within the negative-resistance region, BC. But it will be stable when the operating point is in either the AB or CD region.

Basic bistable switching circuit

With the proper bias voltages, the value of external emitter resistance, R_e , may be chosen to place the operating point in any of the three regions of the characteristic curve. The requirement that the load resistance be higher in value than the negative resistance must be satisfied to achieve single operating points, as shown in Fig. 703.

When the value of R_e is *less* than the negative resistance, as illustrated by the dashed line in Fig. 704, and the bias voltages are adjusted properly, the load line can be made to intersect each region once, and to give the multiple operating points a, b, and c.

The circuit may be adjusted for operation in the manner described by Fig. 704 and emitter-biased to the operating point a

along the cutoff region. Collector current flow is low at this point. This is the OFF condition of the switching circuit. If the negative value of v_e then is decreased (for example, by the application of a positive pulse to the emitter) so as to move the operating point from a to and over the upper turning point, B, the operating point will flip quickly into the saturation region CD and will fall back to c when $-v_e$ returns to point a. The operating point does not pause at b, since operation is unstable in the BC negative-resistance region.

The circuit now will operate indefinitely at point c which

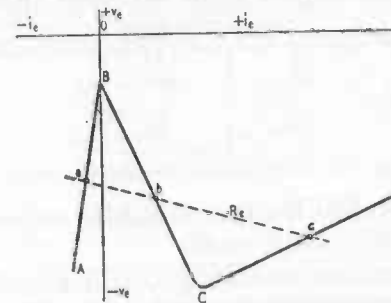

Fig. 704. Emitter negative-resistance characteristic with multiple operating points.

represents a high collector-current level. This is the ON condition of the switching circuit. Further application of positive pulses to the emitter will have no further switching effect. Note that this action resembles that of a Thyatron tube in which all grid control is lost once the tube has been fired by the grid pulse.

With the circuit operating in a stable manner at point c, the application of a negative trigger pulse of suitable amplitude to the emitter will shift the operating point down and around the lower turning point C. The operating point then flips to region AB, since it cannot stop in the negative-resistance region, BC. Actually, pulses may be applied also to the base. A base pulse of the same polarity will switch the circuit in the opposite direction.

From the foregoing description, it is seen that operation is flipped suddenly from a to c by a positive emitter pulse, and back again from c to a by a negative pulse. The operating point remains wherever it is until the next pulse of proper polarity arrives. Collector output is low and the switch is said to be OFF when the operating point is at a. Conversely, collector output is high and the switch is said to be ON when the operating point is at c.

This arrangement is a rudimentary, bistable transistor switch or flip-flop. The speed at which the operating point moves between the ON and OFF conditions is governed by operating parameters and by the internal properties of the transistor itself. Commercial switching-type transistors are available with rise times as fast as 0.10 microsecond (10 megacycles). In general, fall times are somewhat slower than rise times.

Monostable circuit—single shot

A *single-shot* or *one-shot* circuit by successive ON-OFF action gives one complete output pulse for each input trigger pulse.

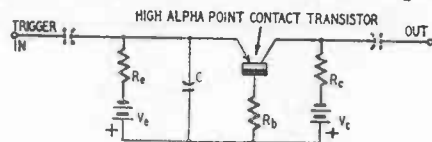

Fig. 705. Single-shot (monostable) circuit.

Note, however, that this is a true switching action and not merely amplification of the control pulse.

The simple transistor switching circuit already described can be adapted for single-shot operation by the addition of a capacitor C between emitter and ground, as shown in Fig. 705.

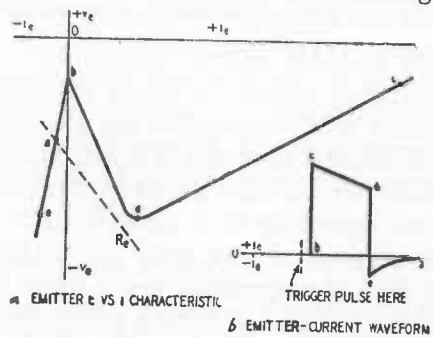

Fig. 706. Monostable circuit characteristics.

For an illustration of the monostable circuit characteristic, refer to Fig. 706-a. The values of emitter external resistance R_e and of negative emitter bias V_e are chosen such that R_e has a value less than the negative-resistance slope, bd , and the load line intersects the characteristic at one point, a , in the cutoff region.

When the emitter voltage v_e is reduced, such as by application of a positive pulse to the emitter electrode, the operating point is moved up the cutoff region and around the upper turning

point, b . However, capacitor C cannot charge instantaneously (in fact, it resists a voltage change) and it effectively short-circuits the emitter to immediate voltage changes. The operating point accordingly does not move in the normal fashion down to d , but flips quickly to the second current value which i_e can have at voltage b . This point is c in the saturation region. But c in this case is not completely stable. Capacitor discharge brings the operating point slowly from c down to the lower turning point, d . This is another point only apparently stable, so the operating point flips quickly to the second current value at this voltage, which is point e in the cutoff region. From this point, also only apparently stable, the operating point then returns slowly to its

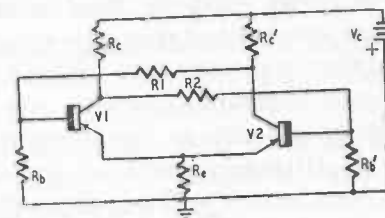

Fig. 707. Basic transistor binary counter.

original location, a . This finishes the complete cycle resulting from application of the trigger pulse.

Fig. 706-b shows the shape of the resulting emitter current waveform. Points on this illustration have been lettered to correspond to those mentioned in the preceding explanation and appearing along the curve in Fig. 706-a. The quick and slow changes may be detected easily in Fig. 706-b.

The circuit oscillates when R_e is higher than the negative resistance, and the load line intersects the curve at one point in the negative resistance region. Oscillations are of the relaxation type, similar to those produced by corresponding gaseous-tube sawtooth generator circuits. Capacitor C charges through resistance R_e at a rate determined by the time constant of the r - c combination. It then is discharged by the transistor, and the cycle is repeated.

Two-transistor binary counter

The basic circuit of a 2-transistor binary counter is shown in Fig. 707. Operation is enhanced when the two transistors have identical electrical characteristics. Distinguishing features of this circuit, which resembles the Eccles-Jordan tube circuit, are the common emitter resistor (R_e) and the cross-coupling resistors

(R1 and R2). In some applications, R_c is returned to a bias voltage.

With matched transistors; $R_c = R_c'$, $R1 = R2$, and $R_b = R_b'$. Output can be taken from one or both collectors. Input trigger pulses may be applied to either base electrode at a time.

When the bias voltage is switched on, one transistor will conduct with high collector current and is stable in the saturation region of the negative-resistance characteristic. At the same time, the other transistor will be stable at the same voltage point in the cutoff region of the characteristic and will conduct with considerably less collector current. Thus, one transistor may be said to be ON and the other OFF. This condition is secured through the cross-coupling resistors. Both emitters receive the same value of emitter bias voltage from the common resistor, R_e .

Application of a pulse to the OFF base will switch this transistor on while simultaneously switching the other one off. Application of a pulse of the same polarity to the opposite base then will reverse the states. If alternate pulses of opposite polarity are applied to one base, conduction will be switched alternately back and forth between transistors V1 and V2.

RECOMMENDED READING

1. *Two-Transistor Binary Counter*. R. L. Trent. ELECTRONICS, July 1952. p. 100.
2. *Dynamics of Transistor Negative-Resistance Circuits*. B. G. Farley. PROCEEDINGS OF THE I.R.E., November 1952. p. 1497.
3. *Transistor Trigger Circuits*. A. W. Lo. PROCEEDINGS OF THE I.R.E., November 1952. p. 1531.
4. *Counter Circuits Using Transistors*. E. Eberhard, R. O. Endres, and R. P. Moore. RCA REVIEW, December 1949. p. 459.
5. *Transistor Trigger Circuits*. H. J. Reich and R. L. Ungvary. REVIEW OF SCIENTIFIC INSTRUMENTS, August 1949. p. 586.
6. *Transistors in Switching Circuits*. A. Eugene Anderson. PROCEEDINGS OF THE I.R.E., November 1952. p. 1541.
7. *Graphical Analysis of Some Transistor Switching Circuits*. L. P. Hunter and H. Fleisher. PROCEEDINGS OF THE I.R.E., November 1952. p. 1559.
8. *A Transistor Reversible Binary Counter*. Robert L. Trent. PROCEEDINGS OF THE I.R.E., November 1952. p. 1562.
9. *A Transistor Shift Register and Serial Adder*. James R. Harris. PROCEEDINGS OF THE I.R.E., November 1952. p. 1597.
10. *United States Patent No. 2,622,211* issued to Robert L. Trent, assignor to Bell Telephone Laboratories, Inc.

Chapter 8

Practical Transistor Circuits

THE illustration, Fig. 801, shows four single-stage audio amplifiers of the r-c coupled type. The first employs a point-contact transistor; the other three use P-N-P junction transistors. Although the circuits of the latter three amplifiers were worked out with P-N-P units, N-P-N transistors also can be used, provided bias polarities are reversed.

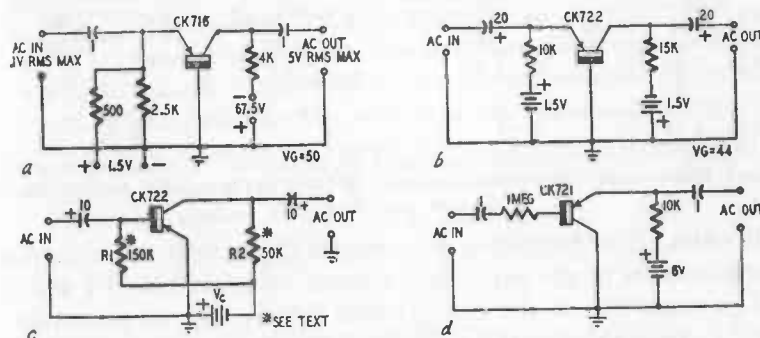

Fig. 801. Resistance-coupled, single-stage a.f. amplifiers.

Fig. 801-a is a grounded-base circuit with a point-contact transistor. The voltage gain of this stage is 50, as measured, but will vary somewhat with individual transistors. Maximum r.m.s. input voltage before peak clipping is 0.1 volt. Maximum output to a high-impedance load (100,000 ohms or higher) is 5 volts r.m.s. Frequency response is flat within ± 1 db from 20 cycles to 20 kc.

Fig. 801-b shows a grounded-base stage with a junction transistor. Voltage gain is 44, but will vary with individual transistors. Frequency response is flat within $\pm 1\frac{1}{2}$ db from 20 cycles to 10 kc. A high-impedance load (100,000 ohms minimum) must be used.

The grounded-emitter junction transistor stage, Fig. 801-c, has a voltage gain of 50 when the single bias battery, V_c , is $1\frac{1}{2}$ volts and is 100 when V_c is 3 volts. The impedance of the external load device must be 200,000 ohms or higher to realize the full voltage gain. Both resistors, R1 and R2, must be selected in value for individual transistors. Resistor R1 must be chosen for the best compromise between voltage gain, low noise, and minimum distortion.

Fig. 801-d shows a grounded-collector, junction transistor stage which is comparable to a cathode-follower tube stage. Input impedance at 1,000 cycles was measured as 1.3 megohms with 10,000-ohm output. The input impedance will vary widely with individual transistors and drops off in varying amounts as the signal frequency is increased beyond 5 kc.

Single-stage transformer-coupled a.f. amplifiers

Fig. 802-a shows a single-stage, grounded-base audio amplifier designed for operation between 500-ohm input and 500-ohm output. At 1,000 cycles, power gain is 20 db, and power output 50

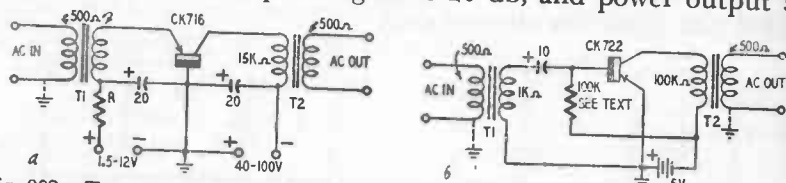

Fig. 802. Transformer-coupled single-stage a.f. amplifiers. (a) grounded-base point-contact (power gain, 20 db; power output, 50 mw), (b) grounded emitter, junction (power gain, 30-35 db).

milliwatts. The frequency response is dependent upon response characteristics of the input and output transformers, T1 and T2.

The exact size of the emitter bias supply will be governed by the d.c. resistance of the secondary winding of transformer T1. The same is true of the resistance R which is included for constant-current purposes. The exact size of the collector bias supply likewise will be governed by the d.c. resistance of the primary winding of output transformer T2. Both the emitter and collector bias voltages must be chosen to give rated emitter-to-base and collector-to-base voltages with the transformers in the circuit.

This same circuit may be employed for operation between input and output impedances other than 500 ohms. The emitter impedance of the transistor is taken as approximately 500 ohms, the collector impedance as 15,000 ohms. The transformer turns ratios may be chosen for operation between these impedances and any desired source and load impedances.

Fig. 802-b is the circuit of a similar transformer-coupled stage for operation between a 500-ohm source and 500-ohm load, but employing a grounded-emitter connection. The power gain is 30 to 35 db. Power output will be 2 milliwatts or less but may

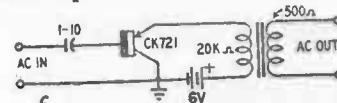

Fig. 802-c. Single-stage a.f. amplifier. (input impedance, 0.3-0.5 megohm at 1 kc; power gain, 10-12 db).

be increased by raising the bias voltage if the maximum permissible collector dissipation is not exceeded.

The value of 100,000 ohms given for the base resistor is typical. However, this resistance must be chosen carefully for the individual transistor used. It should limit the no-signal collector current to a maximum of 150 microamperes d.c. Final adjustment of the base resistor should be made with an input signal and with the aid of an output a.c. vacuum-tube voltmeter, oscilloscope, and listening device (high-impedance-input amplifier with headphones). The final value of resistance should give the best compromise between high output, low noise, and low distortion.

Fig. 802-c is the circuit of a transformer-coupled, grounded-collector stage. This circuit, which is similar to a vacuum-tube cathode follower, has a measured 1-kc input impedance of 0.3 to 0.5 megohm and a power gain of approximately 12 db. As shown,

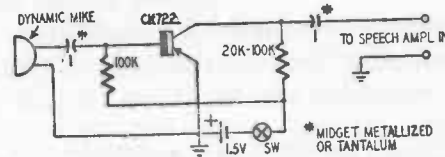

Fig. 803. Subminiature amplifier for inclusion in mobile dynamic microphone.

the output transformer operates into a 500-ohm load, but a 20,000-ohm transformer having any other desired secondary impedance may be substituted.

Microphone-case preamplifier

The single-stage r-c coupled amplifier circuit shown in Fig. 803 can be made small enough in size to fit into the case of a small dynamic microphone. The circuit is seen to be of the same general design as the one shown in Fig. 801-c.

The voltage gain provided by this preamplifier allows a good-

quality dynamic microphone to be used in a mobile transmitter. Space and power requirements usually limit such transmitters to poorer-grade carbon microphones, since the latter have higher-voltage output and therefore require less speech amplification.

Multistage r-c coupled a.f. amplifier

Fig. 804 is the circuit of a 4-stage r-c coupled audio amplifier using type CK721 P-N-P junction transistors in the grounded-emitter connection. Overall power gain is 100 db. Power output

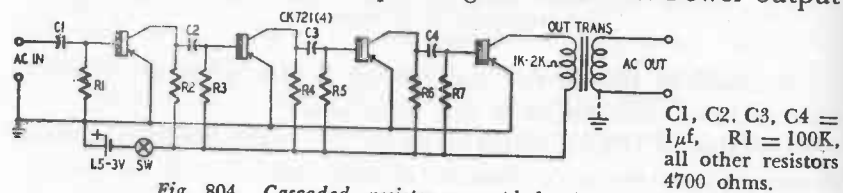

Fig. 804. Cascaded, resistance-coupled a.f. amplifier.

to a matched load will be approximately $2\frac{1}{2}$ milliwatts. The resistors shown are good compromise values and can be adjusted to lower or higher values for optimum operation of individual transistors.

The input impedance will be of the order of 1,000 ohms for a battery voltage of $1\frac{1}{2}$ volts and approximately 800 ohms for 3 volts. A volume control may be added to the circuit, if desired, in the manner described in Chapter 4. The output transformer T may be chosen to match the load device used. Its primary impedance should be 1,000 to 2,000 ohms.

Multistage transformer-coupled a.f. amplifiers

Transformer coupling between transistor amplifier stages provides impedance matching and allows the use of less stages for

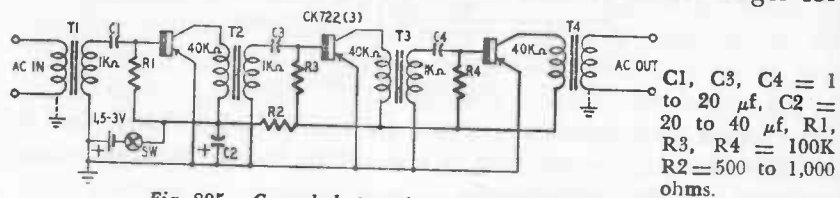

Fig. 805. Cascaded, transformer-coupled a.f. amplifier.

the same overall gain than in r-c interstage coupling. Over-all voltage amplification, as well as power amplification, is improved. The transformer-coupled amplifier is not as compact as the r-c coupled version, however, even when subminiature transformers are used.

Fig. 805 is the circuit of a 3-stage transformer-coupled audio

amplifier having an over-all power gain of 90 db and power output of approximately 2 milliwatts. Type CK722 junction transistors are used. Frequency response is governed by the response characteristics of the transformers. The frequency range will be improved by using high capacitances (10 to $20\mu\text{f}$) for C1, C3, and C4.

Input impedance of the input transformer T1 must be selected to operate between the source impedance and 1,000 ohms trans-

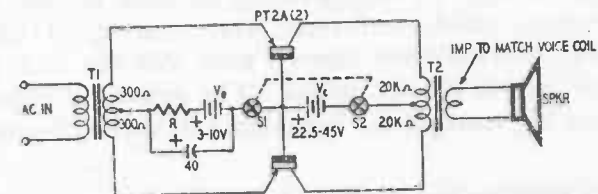

Fig. 806. Push-pull a.f. amplifier for speaker operation (signal driving power, 2 mw; power output, 100 mw).

istor input. The secondary impedance of the output transformer T4 must match the load device.

Resistors R1, R3, and R4 are shown as 100,000 ohms each, but their values must be adjusted for the individual transistors used, to give the best compromise between high gain, low noise, and low distortion. Resistor R2 and capacitor C2 form a decoupling filter for the elimination of motorboating. A volume control may be added, if desired, in the manner explained in Chapter 4.

Boosting audio power output

Power output of the amplifiers shown in Figs. 802, 804, and 805 can be boosted by increasing the collector voltage and current to the maximum permissible values for the transistor used, provided the allowable maximum collector dissipation is not exceeded. Maximum permissible collector dissipation of the type CK721 and CK722 is 30 milliwatts. When battery bias supply is used, power-drain economy makes advisable the operation of the boosted output stage from a separate battery.

Push-pull amplifier for speaker operation

The push-pull point-contact amplifier shown in Fig. 806 has a power output of approximately 100 milliwatts (signal driving power of 2 milliwatts) and accordingly is capable of fair loud-speaker operation. This amplifier may be used conveniently as the output stage of other transistor amplifiers, receivers, intercoms, etc. Matched type PT-2A transistors are employed. Similar point-contact transistors will give comparable power output.

The primary impedance of the input transformer T1 must match the input signal-source impedance. The secondary of T1 matches 300 ohms each side of center tap. The exact value of the emitter bias supply voltage, V_e , (3 to 10 volts) and of the current-stabilizing resistor R will be governed by the d.c. resistance of the T1 secondary. The voltage must develop, through the transformer, a no-signal emitter current of 1 ma d.c. The collector bias supply voltage, V_c , must develop, through the d.c. resistance of the output transformer secondary, a no-signal collector-to-base voltage and collector current such that for each transistor the product $v_c i_c$ is 100 milliwatts. The secondary impedance of transformer T2 matches the impedance of the loudspeaker voice coil.

Transistor hearing aid

Fig. 807 gives the circuit of a simple transistor-type hearing aid that can be built from relatively inexpensive parts.

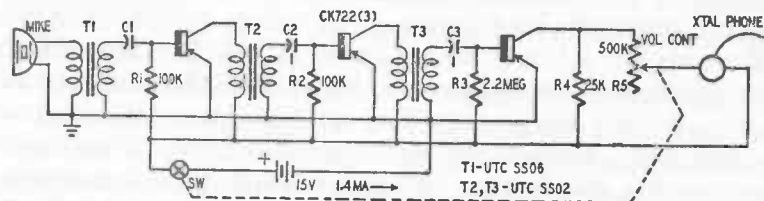

Fig. 807. Simple transistor-type hearing aid. All coupling capacitors can have the same value.

A crystal-type hearing-aid microphone (Brush BB-142-2), crystal-type hearing-aid earpiece (Brush EB), and subminiature U.T.C. transformers are employed. The volume control (R5) is a Centralab B16-218 "dime-sized" potentiometer with attached switch S. Three CK722 junction transistors are used in the grounded-emitter connection. The single battery is a Burgess U10 15-volt miniature unit. Total current drain is only 1.4 ma and may be even less with some transistors.

The base resistors (R1 and R2) must be selected for individual transistors but are apt to have values close to the 100,000 ohms specified in Fig. 807. Their final values must be chosen for the best compromise between high gain, low noise, and low distortion. This instrument gives a good strong signal and is economical of batteries.

Simplified single-stage hearing aid

For use by the not-too-hard of hearing, the very simple circuit of Fig. 808 offers interesting possibilities as an inexpensive hearing

aid. This instrument may be employed to some extent also as a stethoscope, detectaphone, and sound-pickup device where the high gain of the hearing aid shown in Fig. 807 is not required. Aside from lower gain, this circuit also has the disadvantage of

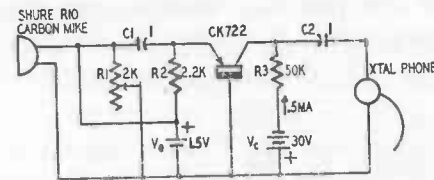

Fig. 808. Single-stage experimental hearing aid.

higher noise level as the result of hiss generated by the carbon microphone.

A single CK722 transistor is used in the grounded-base r-c coupled connection. The emitter bias battery, V_e , also supplies current to the carbon microphone. The microphone load resistor, R1, is adjusted for best compromise between high gain and low noise level. The value of the collector load resistor, R3, will vary somewhat with individual transistors and should be chosen for highest output signal.

Basic audio oscillator

Fig. 809 shows the circuit of a simple transformer-feedback audio oscillator using a CK716 point-contact transistor in the

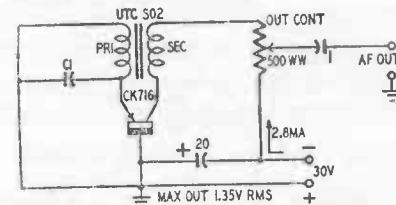

Fig. 809. Audio oscillator-modulator.

grounded-base connection. A subminiature U.T.C. type SO2 transformer (3-to-1 primary-to-secondary turns ratio) was used in the laboratory model, but any larger-sized unit with comparable characteristics can be used.

The operating frequency is determined chiefly by the values of the capacitor C1 and the primary inductance of the transformer. The transformer windings must be poled correctly for oscillation. If oscillation is not obtained readily, reversing the connections of one winding will correct the phasing. The oscillator will develop over 1 volt r.m.s. across high values of load impedance,

and may be used directly as a signal source or as a modulator in an r.f. test oscillator.

Low-drain code-practice oscillator

The ability of the junction transistor to operate with low values of d.c. input power is utilized in the code-practice oscillator shown in Fig. 810. A hearing-aid transformer will convert

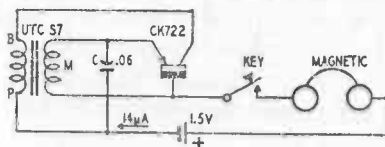

Fig. 810. Code-practice oscillator.

the instrument into a vest-pocket model. This oscillator operates on 14 microamperes supplied by a single $1\frac{1}{2}$ -volt penlight cell. The current will vary one way or the other with individual transistors. With the circuit constants shown, the signal frequency is approximately 700 cycles. The frequency may be increased by decreasing the value of C, and vice versa.

Light-powered audio oscillator

Another interesting oscillator application of the low d.c. requirement of the junction transistor is illustrated in Fig. 811. Here, a miniature transformer-feedback audio oscillator is oper-

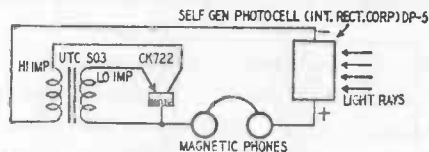

Fig. 811. Light-powered audio oscillator.

ated on the direct current supplied by a self-generating photocell under illumination.

In subdued room light, a 0.02 millivolt r.m.s. audio signal was developed across 2,000-ohm magnetic headphones. A 100-watt lamp, 1 foot from the cell, gave 0.5 millivolt. Between 1 and 2 millivolts were obtained in direct sunlight. The frequency was 900 cycles, but can be lowered by connecting a suitable capacitance in parallel with either the primary or secondary of the transformer. The transformer windings must be poled correctly for oscillation. In lieu of headphones, the oscillator output, developed across a 2,000-ohm resistor, may be presented to an audio amplifier for measurement or control purposes. Low-power-drain

oscillators of this type have been operated also from the direct current obtained from thermocouples, charged capacitors, and similar sources.

Audio signal injector

A signal injector is convenient for introducing a test signal at various points in an audio amplifier during trouble-shooting. A battery-operated, pocket-sized instrument gives the convenience of portability when a full-sized oscillator could not be handled at the test location. A transistor-type injector allows the compactness and economy of single-cell power supply.

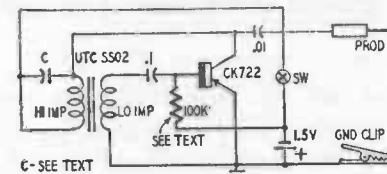

Fig. 812. Audio signal injector for amplifier servicing.

The signal injector circuit shown in Fig. 812 employs a CK722 transistor as a grounded-emitter transformer-feedback oscillator. The transformer is a U.T.C. type SS02 subminiature hearing-aid unit. A single $1\frac{1}{2}$ -volt penlight cell supplies power. The entire instrument can be assembled into the shell of a test probe.

The transformer windings must be poled correctly for oscillation. The 100,000-ohm resistor will be correct in most cases but may be increased or decreased to match individual transistors. It should be adjusted for a collector current lower than 0.5 ma d.c. The signal frequency can be adjusted in steps by means of fixed capacitors in parallel with either the primary or secondary of the transformer.

Single-transistor multivibrator

Fig. 813 shows a multivibrator circuit which utilizes the emitter negative-resistance characteristic of a CK716 point-contact transistor. This circuit will not operate with junction transistors.

The signal frequency will jump abruptly from one value to another as rheostat R1 is adjusted. The waveform and amplitude of the output signal, as well as the ability of the unit to start quickly when switched on, are controlled by the setting of the base rheostat, R2. At any value of collector voltage and setting of R2, the signal frequency is governed chiefly by the value of

C1 and the settings of R1. Values between 25 and 100 kc may be obtained with the circuit constants shown in Fig. 813. A synchro-

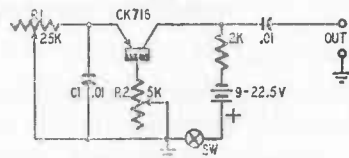

Fig. 813. Multivibrator with single transistor.

nizing voltage may be applied through an isolating capacitor between emitter and ground, or between base and ground.

Musical toy

The frequency of an r-c type transistor oscillator may be changed readily by varying the capacitance in the r-c frequency-determining part of the circuit. When capacitors of different

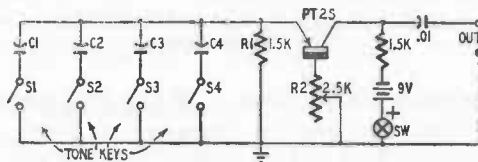

Fig. 814. Oscillator type musical toy.

values are arranged for successive switching into the circuit, the frequency may be changed in steps.

This technique is employed in the point-contact transistor oscillator in Fig. 814 to obtain a desired number of separate tones. The capacitor switches (S1 to S4) may be operated by piano-type keys. The capacitors (C1 to C4) serve to determine the tones. Actually any number can be used for the various notes desired.

Rheostat R2 is adjusted for quick starting of the oscillator. This rheostat also can be set so that the oscillator has no output unless a capacitor is switched into the tone circuit. For close tuning of the frequencies, a single capacitor may be used, and various values of R1 switched into the circuit. The tone resistors can be rheostats for close tuning to the desired notes. The output of the simple step-type oscillator may be fed into an amplifier-loudspeaker system to yield a simple organ-like instrument.

Self-excited 100-kc frequency standard

Fig. 815 shows a 100-kc self-excited oscillator employing a grounded-base point-contact transistor and intended for use as a

secondary frequency standard. This oscillator is used in the conventional manner, and its harmonics supply spot frequencies 100 kilocycles apart.

The series-resonant feedback circuit comprises the 21½-milli-henry r.f. choke (RFC) and capacitors C1 and C2. Careful adjustment of C2 allows the oscillator to be set to zero beat with the

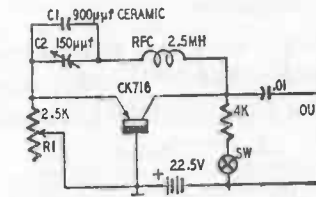

Fig. 815. Self-excited 100-kc frequency standard.

2.5- or 5-mc carrier of Station WWV. Output waveform, as well as readiness of oscillation, may be controlled by adjustment of rheostat R1. For best stability, the oscillator should be built solidly in a metal box with thick walls, the latter serving as a temperature baffle as well as r.f. shielding. Only high-impedance loads should be connected to the output terminals. In most applications, no direct connection need be made, a short piece of wire or a rod antenna providing sufficient radiated signal.

Crystal-type frequency standard

Good stability can be obtained with the crystal oscillator shown in Fig. 816. This circuit resembles the Pierce-type vacuum-tube crystal oscillator in its freedom from tuned circuits. The crystal may be ground for a *fundamental* frequency of 100, 200, or 500 kc.

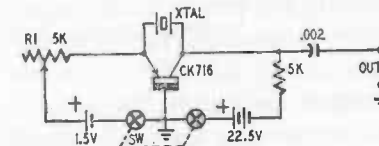

Fig. 816. Crystal-type frequency standard.

Adjustment of the 5,000-ohm rheostat, R1, controls the output waveform, amplitude, and readiness of oscillation. It is not necessary to adjust for sine-wave output, since a standard-frequency oscillator should supply abundant harmonics for spot-frequency checking. Any load device connected to the output terminals should have high impedance, to prevent excessive loading. In many applications, particularly those involving use of a sensitive

radio receiver or monitor, a rod antenna or a short piece of wire connected to the high output terminal will supply sufficient radiated signal.

Another crystal-type 100-kc transistorized standard-frequency oscillator is described in Chapter 5 and is illustrated by Fig. 506-b.

Broadcast-band r.f. amplifier

The circuit of a single-stage r.f. amplifier, suitable for use as a broadcast-band preamplifier or booster, or as a building block in the construction of a transistorized broadcast receiver, is shown

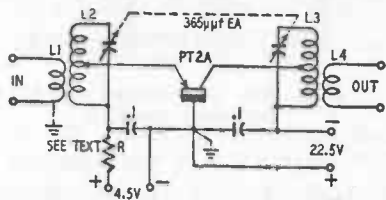

Fig. 817. Broadcast-band r.f. amplifier.

in Fig. 817. A point-contact amplifier-type transistor is used for good frequency response.

The input and output circuits are gang-tuned by the dual 365- μ f variable capacitor. The two sections of this unit must be insulated from each other. Each of the coil combinations (L1-L2 and L3-L4) is a standard broadcast, single-layer-type, antenna-input coil. L2 and L3 are the normal secondaries. The emitter is tapped 2/3 of the way down L2. The collector is tapped 1/2 of the way down L3. In most cases, it will be necessary to remove the regular primary from the output-coil combination and to wind on L4, a new coil having the proper turns ratio with respect to L3 to provide a satisfactory impedance match to the next stage following the r.f. amplifier.

The input and output coils must be mounted at right angles or else well-shielded to prevent feedback coupling. If this is not done, oscillation may result. The constant-current emitter resistor R must be adjusted for a no-signal emitter current of 1 ma and will have a final value in the vicinity of 5,000 ohms. Operating into a matched impedance, a power gain of 70 to 80 times may be expected in the broadcast band.

Diode broadcast receiver with transistor amplifier

Fig. 818 shows the circuit of a simple diode (crystal) broadcast tuner followed by a 2-stage junction transistor amplifier. The

single power supply for this receiver is a 1½- or 3-volt battery. The audio amplifier is transformer-coupled for best interstage impedance match and for highest audio gain. Grounded-emitter stages are used, and the amplifier section is similar to the cascaded amplifier shown in Fig. 805. The 100,000-ohm base resistors R1 and R2 must be adjusted for individual transistors. The proper

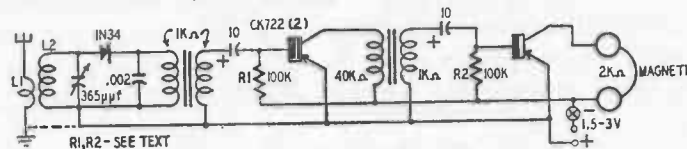

Fig. 818. Diode-type broadcast receiver with transistor a.f. amplifier.

value will limit the no-signal collector current to approximately 100 microamperes d.c.

The input coupler (L1-L2) is a standard broadcast-type antenna-input coil, such as Miller type 20-A. Tuning is accomplished entirely by means of the 365- μ f variable capacitor. The audio output into 2,000-ohm magnetic headphones is approximately 2 milliwatts, depending upon the strength of the received radio signal. This output may be increased by boosting the battery voltage, provided the maximum collector dissipation of 30 milliwatts is not exceeded. The loudspeaker-operating audio output amplifier stage (see Fig. 806) may be added in place of the headphones. For greater sensitivity, and selectivity, the r.f. amplifier (see Fig. 817) may be operated ahead of the diode detector stage. This receiver requires a good outside antenna and a solid ground connection for best performance.

Regenerative broadcast receiver

The increased sensitivity afforded by regeneration in a broadcast detector can be obtained in a point-contact transistor circuit such as is shown in Fig. 819.

The r.f. signal is coupled into the base circuit through the input transformer, L1-L2. This latter is a standard broadcast-type antenna-input coil, such as Miller type 20-A. Tuning is accomplished by means of the single 365- μ f variable capacitor. Improved operation, resulting from a better impedance match, may be obtained with some transistors by tapping the base down the coil L2.

The strength of regeneration is controlled by means of the 5,000-ohm rheostat R. The latter is set for maximum reinforce-

ment of the signal, just short of the point of spill-over oscillation. In lieu of direct headphones, the audio amplifier section shown in Fig. 805 may be transformer-coupled to the regenerative detector output for louder signals.

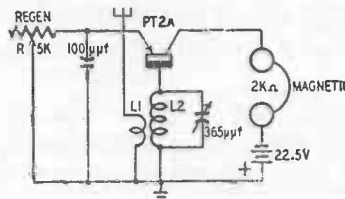

Fig. 819. Regenerative broadcast receiver.

A feature of this simple, sensitive receiver is its adaptability to pocket-size construction. The antenna may be a flexible wire stitched inside the user's coat. In strong field-strength areas, the regenerative detector gives good account of itself.

Phone monitor

The simple diode detector with headphones has been used as a monitor of radio signals since the inception of the germanium diode. With this inexpensive device, aural monitoring of signal

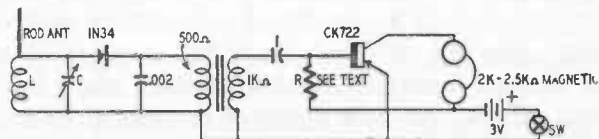

Fig. 820. Monitor for radiophone transmission.

quality is accomplished easily. Diode monitors are found in commercial as well as amateur stations.

A disadvantage of the diode-type monitor has been its low audio output except when operated dangerously close to the radio transmitter. While small-sized audio amplifiers have been added on occasion, there is general objection to these additions on the grounds that a.c. amplifiers destroy the desirable isolation feature of the instrument and battery-operated amplifiers have not been economical.

The low power requirements of the junction transistor adapt it to use as a single-stage audio headphone amplifier in the diode-type monitor. A circuit is shown in Fig. 820. Here, a grounded-emitter CK722 is transformer-coupled to the monitor-diode output. Coil L and capacitor C are chosen to tune to the carrier

frequency of the transmitter. A short rod antenna, or length of insulated wire, usually will provide enough pickup anywhere in and around the transmitter building. Resistor R will have a value of approximately 100,000 ohms but must be adjusted for a no-signal collector current of not more than 100 microamperes.

Sensitive field-strength meter

Another popular use of the diode detector at radio transmitting stations has been as a simple field-strength meter. This instrument, built around a pickup antenna, germanium diode, and d.c.

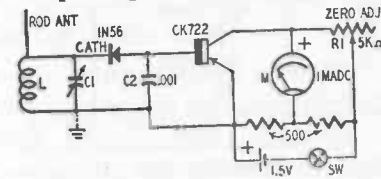

Fig. 821. Sensitive field-strength meter.

milliammeter, is invaluable for carrier monitoring and for making comparative intensity measurements in transmitter and antenna adjustments. The sensitivity of the diode-type field-strength meter is increased by the use of a low-range d.c. microammeter in place of the usual milliammeter. But the microammeter is expensive and often less rugged mechanically.

Fig. 821 shows how a grounded-emitter junction transistor may be used as a d.c. amplifier between the diode output and a 0-1 d.c. milliammeter. A CK722 transistor will provide a base-to-collector current amplification (*beta*) of 10 to 12; a CK721, 30 to 40. Thus, the amplifier circuit converts the 0-1 milliammeter into a 0-100 d.c. microammeter with a CK722, and into a 0-25 microammeter with a CK721.

The d.c. output of the 1N56 diode rectifier passes through the base-emitter input path of the transistor. The diode is poled so that negative voltage is applied to the base of the transistor. Capacitor C2 is for radio-frequency bypassing. The values of coil L and variable capacitor C1 are chosen for resonance at the transmitter carrier frequency. With no r.f. signal input, the meter is set initially to zero by adjusting the zero-set rheostat R1.

Amplifier-type d.c. microammeter

The d.c. amplifier and indicating meter circuit of the field strength meter has been separated in Fig. 822 for use as a sensitive d.c. microammeter. Using a single CK721 or CK722 grounded-

emitter transistor, the 0-1 d.c. milliammeter will read 0-25 d.c. microamperes with a CK721, or 0-100 microamperes with a CK722. A 0-100 d.c. microammeter at M will read 0-2.5 μ a with a CK721, or 0-10 μ a with a CK722.

With no input signal voltage, the meter is set initially to zero, as in a vacuum-tube voltmeter, by adjustment of the zero-set rheostat R2. The d.c. input terminals can be open or shorted for this adjustment. After zero-setting, the circuit is standardized

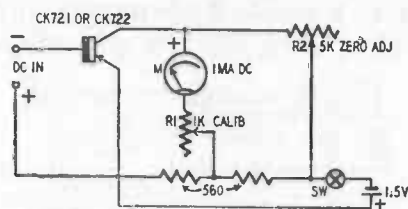

Fig. 822. Amplifier-type d.c. microammeter.

initially by applying an accurately-known d.c. input current corresponding to full-scale deflection of the meter, and adjusting the calibration control rheostat R1 for full-scale deflection. When a 0-1 milliammeter is used, this input current should be 25 μ a for the CK721 or 100 μ a for the CK722. With a 0-100 microammeter, a 2.5 μ a calibration current is used with the CK721 and 10 μ a with the CK722.

Linearity of the instrument is very good. However, an individual calibration should be made when best accuracy is desired. Total drain from the single 1½-volt cell is 1.5 ma at full-scale deflection of the 0-1 milliammeter.

Sensitive d.c. relay

The grounded-emitter junction transistor d.c. amplifier is applicable also for building up small direct currents to levels sufficient to operate a milliamper type d.c. relay. Thus microampere response may be obtained with a more rugged milliamperere relay. Fig. 823 shows the simple circuit which can be used for this purpose.

Best results are obtained with relays having low coil resistance. The collector voltage is chosen such that the steady collector current flowing through the relay coil is somewhat less than required to pick up the relay. A few microamperes applied to the input terminals of the circuit then will actuate the relay. Highest sensitivity is afforded by the high-alpha junction transistors, such

as CK721. The latter provides a base-to-collector amplification of 30 to 40. Current amplification with the CK722 can reach a maximum of 12.

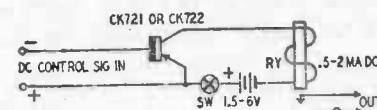

Fig. 823. Amplifier-type sensitive d.c. relay.

Heterodyne frequency meter

The tube-type heterodyne frequency meter is a familiar instrument in laboratories and radio stations for the measurement of radio frequencies by the zero-beat method. The conventional instrument consists of (1) a single-band, unmodulated, tuned r.f. oscillator; (2) aperiodic detector or mixer; and (3) audio "beat-note" amplifier.

The signal of unknown frequency is applied to the detector.

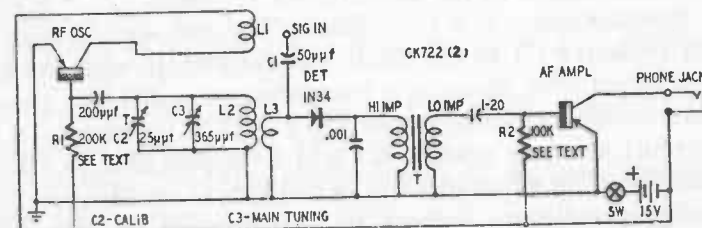

Fig. 824. Transistorized heterodyne frequency meter.

The oscillator frequency then is adjusted to zero-beat with the signal or one of its harmonics. An oscillator harmonic also may zero-beat the signal. At zero beat, the frequency is read from the oscillator dial, and the unknown determined from this reading and the proper harmonic number.

The advantages of a transistorized heterodyne frequency meter are (1) complete isolation, (2) small size and portability, (3) economy of operation not possible with battery-type vacuum tubes, and (4) absence of heating.

Fig. 824 shows the circuit of a transistorized heterodyne frequency meter. The local oscillator employs a CK722 transistor in a grounded-emitter, tickler-feedback circuit. This oscillator tunes from 500 to 1,000 kc and allows identification of signals from 50 kc to 30 mc. Coil L2 consists of 113 turns of no. 32 enameled wire close-wound on a 1-inch-diameter form. L1 is 40 turns of no. 26

enameled wire close-wound on top of L2 and insulated from the latter. The output coupling coil L3 consists of 15 turns of insulated hookup wire jumble-wound and cemented inside of the form on which L2 is wound. Resistor R1 may need adjustment to an individual transistor to insure continuous oscillation throughout the 500-1,000 kc band. The 365- μf variable capacitor C3 is the main tuning control. Capacitor C2 is a calibration trimmer, which

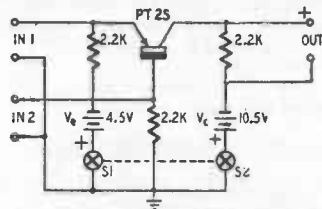

Fig. 825. Single-transistor switching circuit.

is set for zero-beat when C3 is tuned to a harmonic of a 100-kc frequency standard. The 100-kc standard is coupled into the detector by direct connection to the signal input terminal.

The detector-mixer is a 1N34 diode. The test signal is applied through capacitor C1 to the diode simultaneously with the local oscillator signal. The detector is transformer-coupled to a grounded-emitter audio amplifier employing a CK722 transistor. In this latter circuit, the base resistor R2 will be approximately 100,000 ohms but must be adjusted with an individual transistor to limit the no-signal collector current to a maximum of 100 microamperes d.c. Total current drain from a 15-volt hearing-aid-type battery is less than 1 milliampere d.c.

Switching circuit

Fig. 825 shows a single-transistor switching circuit which operates through the use of the emitter negative-resistance characteristic of a PT-2S point-contact unit.

A positive trigger pulse applied to the emitter (input 1) turns the switch on, causing collector current to flow steadily until a turn-off pulse subsequently is applied. A negative pulse applied to the base (input 2) has the same effect. A negative pulse then applied to the emitter (input 1) will turn the switch off, reducing the collector current to a low steady value. A positive pulse applied to the base (input 2) will accomplish the same result.

In the ON condition, collector current is 1.7 ma. In the OFF condition, it is 200 microamperes. Switching frequencies up to 350 kc can be employed with good rectangular-wave output.

Higher switching frequencies are possible with reduced output amplitude and somewhat degraded waveform. The trigger pulse required for switching is 3 volts d.c. or peak a.c. The ON trigger current is 0.8 ma; OFF trigger current is 0.4 ma. An a.c. trigger pulse may be coupled into the emitter or base through a 0.1 μf capacitor.

RECOMMENDED READING

Amplifiers

1. *Transistor Power Amplifiers*. R. F. Shea. *ELECTRONICS*, Sept. 1952. p. 106.
2. *Transistorized Hearing Aids*. J. D. Fahnestock. *ELECTRONICS*, April 1953. p. 154.
3. *Build this Transistor Hearing Aid*. Rufus P. Turner. *RADIO-ELECTRONICS*, Sept. 1953. p. 38.
4. *A Transistor Pre-Amp*. Rufus P. Turner. *RADIO-ELECTRONICS*, Feb. 1953. p. 54.
5. *Transistorize Your Audio Amplifiers*. Charles W. Martel. *RADIO & TELEVISION NEWS*, March 1953. p. 40.

Oscillators

1. *Transistor Oscillator for Telemetering*. F. W. Lehans. *ELECTRONICS*, Aug. 1949. p. 90.
2. *Transistor Oscillator is Powered by Light*. Rufus P. Turner. *RADIO-ELECTRONICS*, Aug. 1953. p. 66.
3. *Low-Drain Transistor Oscillator*. D. E. Thomas. *PROCEEDINGS OF THE I.R.E.*, Nov. 1952. p. 1385.
4. *Transistor Oscillator Circuit*. L. Fleming. *ELECTRONICS*, June 1953. p. 196.
5. *Transistor Oscillators with Crystal Control*. Nathaniel Rhita. *RADIO-ELECTRONICS*, April 1952. p. 56.

Receivers

1. *Crystal Receiver with Transistor Amplifier*. Rufus P. Turner. *RADIO & TELEVISION NEWS*, January 1949. p. 38.
2. *A Study of Transistor Circuits for Television*. G. C. Sziklai, R. D. Lohman, and G. B. Herzog. *PROCEEDINGS OF THE I.R.E.*, June 1953. p. 708.
3. *Transistorizing Communications Equipment*. G. S. Epstein, J. A. Bush, and B. Shellhorn. *ELECTRONICS*, May 1952. p. 98.
4. *Portable Transistor FM Receiver*. R. C. Ballard. *TELE-TECH*, Aug. 1953. p. 79.
5. *Transistor Intermediate Frequency Amplifiers*. (Booklet). J. R. Nelson. Raytheon Mfg. Co.; Newton, Mass.

6. *Build this Transistor Receiver*. Robert K. Dixon. RADIO & TELEVISION NEWS, Feb. 1953. p. 35.

Instruments and Control

1. *Control Applications of the Transistor*. E. F. W. Alexander. PROCEEDINGS OF THE I.R.E., Nov. 1952. p. 1508.
2. *Transistor Band Spotter*. P. G. Sulzer. RADIO & TELEVISION NEWS, June 1953. p. 52.
3. *Transistor Control Relay*. E. Bohr. RADIO-ELECTRONICS, July 1953. p. 53.
4. *Transistor Microammeter*. N. Rhita. RADIO-ELECTRONICS, June 1953. p. 49.

General

1. *Some Novel Circuits for the Three-Terminal Semiconductor Amplifier*. W. M. Webster, E. Eberhard, and W. E. Barton. RCA REVIEW, Vol. 10. p. 5.
2. *Transistor Negative-Impedance Converters*. J. G. Linvill. PROCEEDINGS OF THE I.R.E., June 1953. p. 725.
3. *Symmetrical Properties of Transistors and Their Applications*. George C. Sziklai. PROCEEDINGS OF THE I.R.E., June 1953. p. 717.
4. *Application of Transistors to High-Voltage Low-Current Supplies*. G. W. Bryan. PROCEEDINGS OF THE I.R.E., Nov. 1952. p. 1521.
5. *Junction Transistor Circuit Applications*. P. G. Sulzer. ELECTRONICS, Aug. 1953. p. 170.
6. *Printed Circuitry for Transistors*. S. F. Danko and R. A. Gerhold. PROCEEDINGS OF THE I.R.E., Nov. 1952. p. 1524.
7. *Experimental Circuits for Crystal Triodes*. Rufus P. Turner. RADIO-ELECTRONICS, June 1950. p. 66.
8. *Build a Transistor*. Rufus P. Turner. RADIO-ELECTRONICS, May 1949. p. 38.
9. *Care of Transistors*. Rufus P. Turner. RADIO & TELEVISION NEWS, Feb. 1953. p. 40.
10. *The Transistor in Simple Circuits*. William H. Minor. RADIO-ELECTRONIC ENGINEERING, Dec. 1952. p. 14.
11. *Junction Transistor Circuits*. AEROVOX RESEARCH WORKER, April-May 1953. AEROVOX Corp.; New Bedford, Mass.

Chapter 9

Tests and Measurements

THE measurement of d.c. voltages and currents at emitter, collector, and base electrodes are fundamental in determining transistor operating characteristics. Equipment required for these tests are a high-resistance d.c. vacuum-tube voltmeter (minimum input resistance of 10 megohms), low-resistance current meter (d.c. milliammeter or microammeter, as current level demands), and separate, adjustable constant-current d.c. supplies. While it is desirable in some tests to have separate voltmeters and current meters for each electrode, economy often dictates that switching arrangements be worked out for transferring a single pair of instruments between parts of the test circuit.

In testing transistors, a given current is passed into the electrode of interest. The resulting voltage then is measured between that electrode and the *reference electrode* (usually, base or emitter). This test is always made at some specified constant value of current in the third electrode. For example: a current of 2 ma d.c. from one bias supply is passed through the emitter-to-base circuit of a transistor, while holding constant at 10 ma d.c. the current (furnished by a second supply) through the collector-to-base circuit. The corresponding collector-to-base voltage then is measured.

The collector polarity is negative and emitter positive in point-contact transistors made with N-type germanium, and in P-N-P junction transistors. The collector polarity is positive and emitter negative in N-P-N junction units. Throughout this chapter, polarities shown in the drawings are correct for N-type point-contact and P-N-P junction units. When checking N-P-N junction and P-type point-contact units, reverse all bias polarities shown.

Transistors normally are tested in the grounded-base or ground-emitter circuit. In the grounded-base circuit, the emitter is the input electrode, the collector the output electrode, and emitter and collector voltages are referred to the base. In the ground-emitter circuit, the base is the input electrode, and base and collector voltages are referred to the emitter. In the grounded-base test circuit, emitter and collector currents are measured, while in the ground-emitter circuit, base and collector currents are measured.

It is insufficient to specify current and voltage *only* for a transistor electrode. In order for the information to be complete, one must state also at what value of current in the opposite electrode the measurements apply. This must be done even when the reference current is zero. Thus, it is meaningless to say only that collector current is 1.5 ma and collector-to-base voltage is 10 volts in a grounded-base test circuit. We must indicate that these values are obtained when the emitter current is 0.1 ma.

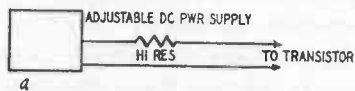

Fig. 901-a. Adjustable d.c. power supply with current-regulating resistor.



Fig. 901-b. Battery with potentiometer and current-regulating resistor.

Constant-current d.c. supplies

The constant-current type of d.c. bias supply is essential in transistor testing, especially for furnishing bias to the emitter or base input electrode. If a specially-designed supply unit of this type is not available, constant current may be obtained from a d.c. voltage supply or battery in the manner shown in Fig. 901. In each example, the voltage of the source is considerably higher than that required at the transistor electrode, and a high resistance is connected in series with one of the output terminals. This resistance, instead of the transistor parameters, consequently determines the magnitude of current.

In Fig. 901-a, an adjustable-output d.c. power supply is used. The output current is varied in magnitude by adjusting the output voltage of the supply. In Fig. 901-b a battery and potentiometer (R1) are used as the adjustable-voltage source, and a high resistance (R2) is connected in series with one output lead for current regulation. The series resistance in each circuit should be as high as practicable in value (100 to 1,000 times the transistor

resistance into which the current is introduced). This means that the source voltage also must be high. As an example, a 100-volt supply in series with 25,000 ohms can be used to supply constant emitter currents up to 2 ma. The voltage at the emitter would be of the order of 0.2 volt.

Regarding constant-current supplies, a word of caution is in order. When the transistor is disconnected, the entire supply voltage appears at the current terminals. This can constitute a shock hazard, especially when supply voltages of several hundred

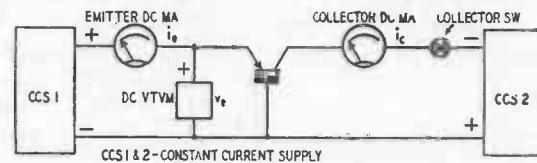

Fig. 902-a. Test circuit for measurement of input characteristics.

volts are employed. The operator must be careful that the power is switched off before removing the transistor or current leads from the test circuit.

Two constant-current d.c. bias supplies are required in transistor testing—one for the collector and the other for the emitter or base.

Measurements for characteristic curves

Figs. 902 to 905 show test-circuit setups for taking current and

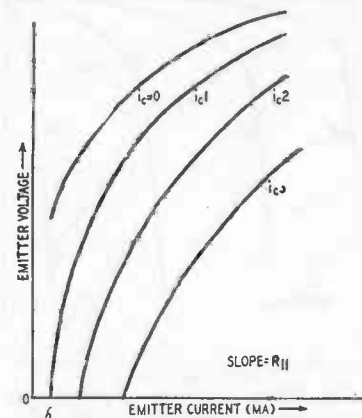

Fig. 902-b. Input characteristic curves.

voltage points for transistor characteristic curves. The test procedures are described separately in the following paragraphs.

Input characteristic This is a plot of emitter current vs. emitter voltage for a constant value of collector current. The test circuit is shown in Fig. 902-a.

Select several values of collector current (i_c) at which measurements will be made. Take points for the first curve at zero collector current by opening switch S temporarily. Vary the emitter current (i_e) between the desired steps by adjusting the output of constant-current supply 1, and record the corresponding emitter voltage (v_e) points. A curve similar to the top one ($i_c=0$) in Fig.

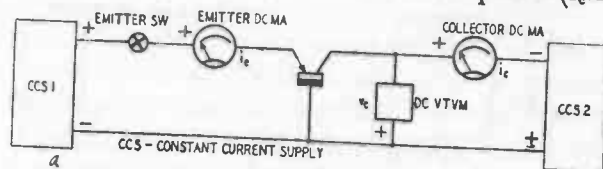

Fig. 903-a. Test circuit for measurement of output characteristics.

902-b will be obtained. Close switch S, and set the collector current to value i_{c1} by adjusting the output of constant-current supply 2. Vary the emitter current in steps, as before, and record corresponding emitter voltage points while holding the collector current constant. Repeat this procedure for constant collector-current values i_{c2} , i_{c3} , etc. A family of curves similar to Fig. 902-b will be obtained.

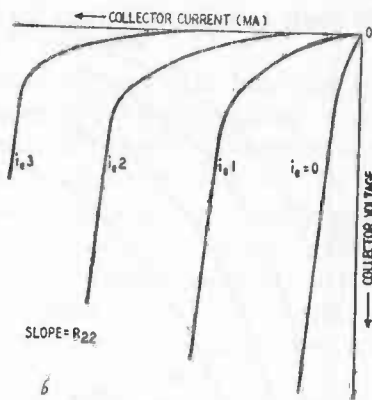

Fig. 903-b. Output characteristic curves.

Output characteristic This is a plot of collector current vs. collector voltage for a constant value of emitter current. The test circuit is shown in Fig. 903-a.

Select several values of emitter current (i_e) for the measurements. Take points for the first curve at zero emitter current by opening S temporarily, varying the collector current (i_c) by adjustment of constant-current supply 2, and recording corresponding collector voltage (v_c) points. A curve similar to the lowest one ($i_e=0$) in Fig. 903-b will be obtained. Close switch S, and set the emitter current to value i_{e1} by adjusting the output of constant-current supply 1. Vary the collector current in steps, as before, and record corresponding collector voltage points while holding the emitter current constant. Repeat this procedure for constant emitter-current values i_{e2} , i_{e3} , etc. A family of curves similar to Fig. 903-b will be obtained.

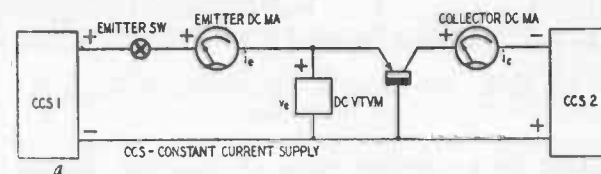

Fig. 904-a. Test circuit for measurement of feedback characteristics.

Feedback characteristic This is a plot of collector current vs. emitter voltage for a constant value of emitter current. The test circuit is shown in Fig. 904-a.

Select several values of emitter current (i_e) at which measurements will be made. Take points for the first curve at zero emitter

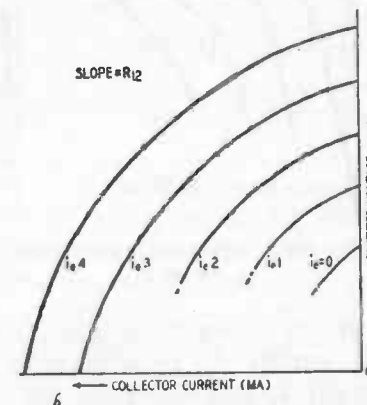

Fig. 904-b. Feedback characteristic curves.

current by opening switch S temporarily, varying the collector current (i_c) by adjustment of constant-current supply 2, and recording the corresponding collector voltage (v_c) points. A curve

similar to the lowest one in Fig. 904-b ($i_b=0$) will be obtained. Close switch S, and set the emitter current to value i_{e1} by adjusting the output of constant-current supply 1. Vary the collector current in steps, as before, and record corresponding collector voltage points while holding the emitter current constant. Repeat this procedure for constant emitter-current values of i_{e2} , i_{e3} , etc. A family of curves similar to Fig. 904-b will be obtained.

Forward characteristic This is a plot of emitter current vs. col-

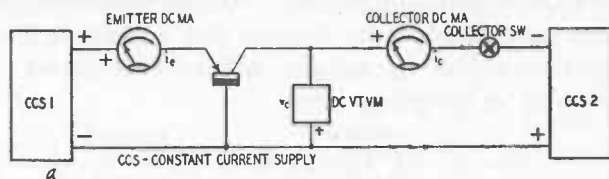

Fig. 905-a. Test circuit for measurement of forward characteristics.

lector voltage for a constant value of collector current. The test circuit is shown in Fig. 905-a.

Select several values of collector current (i_c) at which measurements will be made using constant current supply 2. Take points

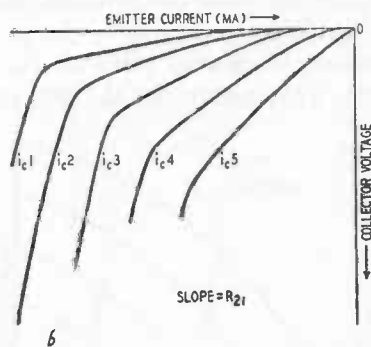

Fig. 905-b. Forward characteristic curves.

for the first curve at the constant collector current value of i_{c1} , varying the emitter current (i_e) by adjustment of the output of constant-current supply 1, and recording the corresponding collector voltage (v_c) points while holding the collector current constant. A curve similar to the top one in Fig. 905-b (i_{c1}) will be obtained. Repeat this procedure for constant collector current values i_{c2} , i_{c3} , etc. A family of curves similar to Fig. 905-b will be obtained.

Output characteristic of grounded-emitter

This is a plot of collector current vs. collector voltage for a constant value of base current. The test circuit is shown in Fig. 906-a.

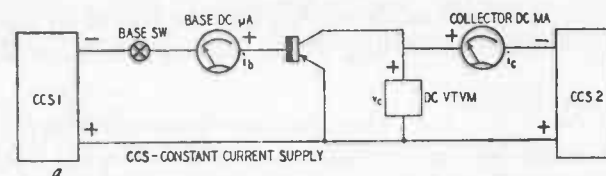

Fig. 906-a. Test circuit for measurement of grounded-emitter output characteristic.

Select several values of base current (i_b) at which measurements will be made. Take points for the first curve at zero base current by opening switch S temporarily, varying the collector current (i_c) in steps by adjustment of constant-current supply 2, and recording the corresponding collector voltage (v_c) points.

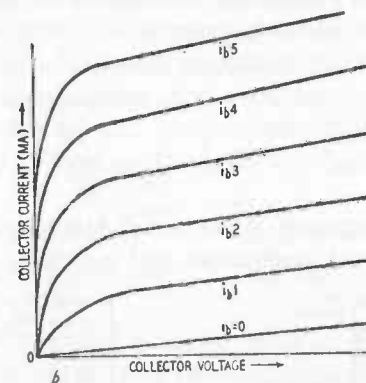

Fig. 906-b. Output characteristic curves of grounded-emitter.

A curve similar to the lowest one in Fig. 906-b ($i_b=0$) will be obtained. Close switch S, and set the base current to value i_{b1} by adjustment of constant-current supply 1. Vary the collector current in steps, as before, and record the corresponding collector voltage points while holding the base current constant. Repeat this procedure for constant base current values i_{b2} , i_{b3} , etc. A family of curves similar to Fig. 906-b will be obtained.

Input, feedback, and forward characteristics also can be checked for the grounded-emitter junction transistor. Use the procedures outlined earlier, except substitute the base for the emitter in each instance, and observe the current-supply polarities shown in Fig. 906-a.

Determination of transistor resistances

The input, output, and transfer resistances of a transistor may be determined from d.c. characteristic curves plotted in the manner described in the preceding section.

The values of *input resistance* R_{11} may be found by measuring the slopes of the curves in Fig. 902-b, *output resistance* R_{22} from

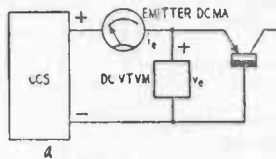

Fig. 907-a. Input resistance measurement.

$$(R_{11} = \frac{v_e}{i_o} \text{ collector circuit open})$$

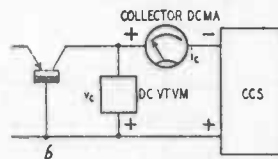

Fig. 907-b. Output resistance measurement.

$$(R_{22} = \frac{v_o}{i_o} \text{ emitter circuit open})$$

the slopes of the curves in Figs. 903-b and 906-b, *feedback resistance (base resistance)* R_{12} from the slopes of the curves in Fig. 904-b and forward transfer resistance R_{21} from the slopes of the curves in Fig. 905-b. From these resistance values, emitter resistance (r_e), collector resistance (r_c), mutual resistance (r_m), and current amplification factor (alpha) can be calculated. For example: $r_e = R_{11} - R_{12}$, $r_c = R_{22} - R_{12}$, and $r_m = R_{21} - R_{12}$. $\alpha = R_{21}/R_{22}$.

The slopes of the curves of the d.c. characteristics give dynamic values of the transistor resistances and are to be preferred. How-

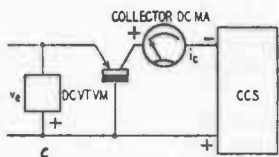

Fig. 907-c. Feedback resistance measurement.

$$(R_{12} = \frac{v_o}{i_o} \text{ emitter circuit open})$$

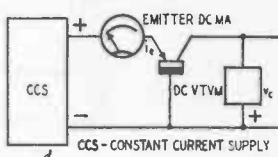

Fig. 907-d. Forward resistance measurement.

$$(R_{21} = \frac{v_o}{i_o} \text{ collector circuit open})$$

ever, the resistances also can be checked statically by means of single-point current and voltage measurements with zero current in the reference electrode (input or output circuit open). For some purposes, resistance values obtained by this method will be sufficient.

The test circuits for static measurements are shown in Fig. 907. The formula for the computation of the applicable resistance appears opposite each circuit.

It should be explained that the high input resistance of the d.c. vacuum-tube voltmeter allows the emitter circuit in Fig. 907-c and the collector circuit in Fig. 907-d to appear open. However, the high collector-to-base terminal resistance of some junction transistors may be significant with respect to the voltmeter resistance and might limit the accuracy of measurement in Fig. 907-d.

Direct measurement of current gain

Current amplification in transistors can be checked by comparing the output-current change with the small input-current change which produces it. The transistor output-electrode voltage is held constant. Both the emitter-to-collector amplification (alpha) and the base-to-collector amplification (beta) can be checked in this manner.

Alpha measurement

The test circuit is shown in Fig. 908-a. The collector supply voltage (V_{cc}) and emitter current (i_e) levels at which the test will be made are chosen from the transistor characteristics sheet. In

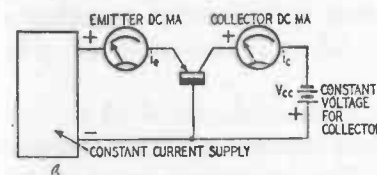

Fig. 908-a. Test circuit for current amplification, alpha.

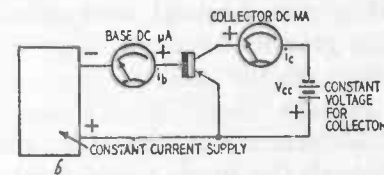

Fig. 908-b. Test circuit for current amplification, beta.

the test, i_e will be varied a small amount above and below the selected operating value, and the corresponding i_c change noted.

By adjustment of the output of the constant-current supply, set i_e to a value 0.1 ma lower than the selected emitter-current value. Record this setting as i_{e1} , and the corresponding collector current as i_{c1} . Next, set the emitter current to a point 0.1 ma higher than the selected value, i_e . Record this new value as i_{e2} , and the corresponding collector current as i_{c2} . Alpha then is determined from the ratio of the collector and emitter current changes. Thus: $\alpha = (i_{c2} - i_{c1}) / (i_{e2} - i_{e1})$.

Alpha measurements may be made at a variety of i_e and V_{cc} values to obtain complete data showing the variation of current amplification with these parameters.

Beta measurement

The test circuit for this measurement is shown in Fig. 908-b.

The collector supply voltage (V_{cc}) and base current (i_b) levels at which the test will be made are chosen from the transistor characteristics sheet. In the test, i_b will be varied a small amount above and below the selected value, and the corresponding change in i_c noted.

By adjustment of the output of the constant-current supply, set i_b to a value 20 microamperes below the selected i_b value. Record this setting as i_{b1} , and the corresponding collector current as i_{c1} . Next, set the base current to a point 20 μ a higher than the selected value, i_b . Record this new setting as i_{b2} , and the corresponding collector current as i_{c2} . Beta then is determined from the ratio of the collector and base current changes. Thus: $\beta = (i_{c2} - i_{c1}) / (i_{b2} - i_{b1})$. Beta measurements can be made at a variety of i_b and V_{cc} values to obtain complete data showing the variation of current amplification with these parameters.

Voltage gain

Voltage gain, or *voltage amplification* may be checked with one of the setups shown in Fig. 909. The grounded-base circuit (Fig. 909-a) may be used with point-contact and junction transistors. The grounded-emitter (Fig. 909-b) and grounded-collector (Fig. 909-c) are for junction types.

In each circuit, the transistor d.c. biases are furnished by constant-current supplies. The sine-wave a.c. test signal is supplied through the input transformer T. The impedance ratio of this component is not important, since only a small input signal voltage is required at the transistor and considerable mismatch loss can be tolerated. The input signal, applied to the transformer primary, is furnished by an oscillator or signal generator. A test frequency of 1,000 cycles is usual for lower-frequency measurements.

The test procedure is the same for each circuit: (1) Select a value for the load resistance, R_L . (2) Adjust the transistor direct currents to their proper operating values according to the characteristics sheet for the type under test. The settings must be made with the a.c. signal absent. (3) Switch the a.c. vacuum-tube voltmeter to the transistor input by throwing switch S to position 1. (4) By means of the output control in the signal generator, set the a.c. signal voltage to a convenient low value (1 to 10 millivolts r.m.s.), as indicated by the vacuum-tube voltmeter. Record this value as E_1 . (5) Switch the vacuum-tube voltmeter to the transistor output, by throwing switch S to position 2, and

read the signal output voltage. Record this value as E_2 . (6) Determine the voltage gain from E_2/E_1 .

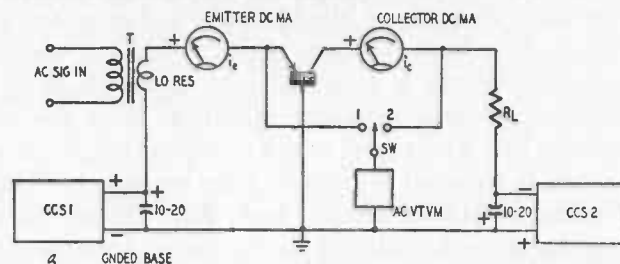

Fig. 909-a. Setup for testing voltage amplification of grounded-base circuit.

The test may be repeated at any desired combination of transistor direct-current levels and at various values of R_L . An oscilloscope should be operated across the load resistor, R_L to monitor

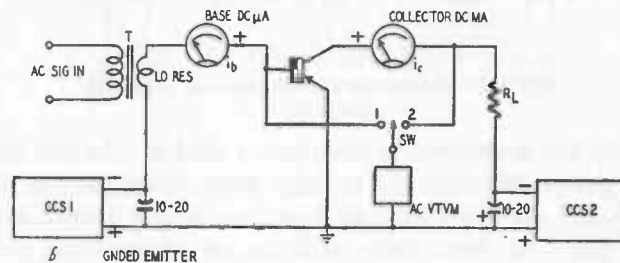

Fig. 909-b. Setup for testing voltage amplification of grounded-emitter circuit.

the output waveform. When severe distortion, such as peak clipping, is evidenced, the input-signal amplitude should be reduced.

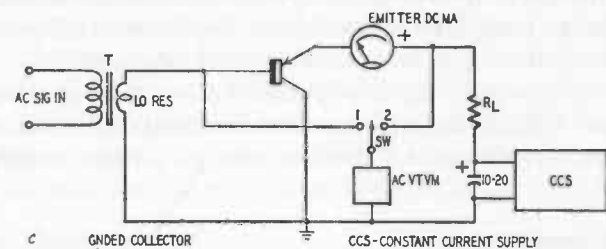

Fig. 909-c. Setup for testing voltage amplification of grounded-collector circuit.

Input impedance

The input impedance of a transistor amplifier or a.c. control circuit may be measured with the test setup shown in Fig. 910.

The test signal is supplied by a suitable source, such as an oscil-

lator or signal generator, having low-impedance output and continuously variable output control. A calibrated, non-inductive, variable resistor (rheostat or decade box) is connected in series with the generator and transistor input. An a.c. vacuum-tube voltmeter-millivoltmeter is arranged with a switch, S, so that it can be switched across the resistor (position 1) or the transistor input (position 2). The signal at the transistor input always must be low enough to forestall overloading the amplifier. The amplifier is terminated with its normal load, R_L . Direct currents are supplied to the transistor circuit in the normal manner and the amplifier is assumed to be in operation.

The test procedure is to adjust R while switching the voltmeter

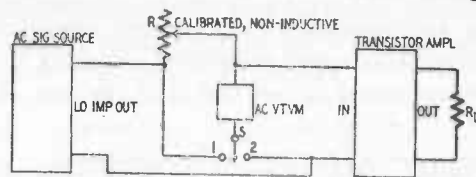

Fig. 910. Circuit for measurement of input impedance.

successively between switch positions 1 and 2. In the first position, the meter will read the voltage drop across the resistor (R); in the second position, the drop across the transistor input impedance (Z). At first, there will be an appreciable difference between these two voltages. But as adjustment of the rheostat proceeds, the difference will decrease. Finally, no voltage change will occur as switch S is thrown between 1 and 2. At this point, $Z = R$, and the impedance value may be read from the dial of the variable resistor. If the resistor is not calibrated for direct readings in ohms, it may be removed from the circuit and its resistance setting checked with a bridge or accurate ohmmeter.

For complete data, input impedance should be checked at several values of R_L unless the latter has been established at a known fixed value. It should be checked also at various transistor bias levels.

Output impedance

The output impedance of a transistor amplifier or oscillator may be checked by means of an external resistor and a.c. vacuum-tube voltmeter. An amplifier must be driven by a signal source, as shown in Fig. 911, but an oscillator will supply its own output voltage for the test. In the case of an amplifier, the output must be monitored with an oscilloscope to forestall overdriving.

The variable resistor R must be noninductive. It may be a laboratory resistance decade box, although a composition-type rheostat can be used. The test procedure is to measure the output voltage with no external load (switch S open), then to connect the load R (switch S closed) and adjust R for a voltage reading equal to one-half the no-load voltage. At this point, the resistance setting of R equals the output impedance of the amplifier or oscillator. If the resistor is not calibrated to read ohms directly, its setting may be checked with a resistance bridge or accurate ohmmeter.

The d.c. output-electrode current of the transistor must not be permitted to flow through the test circuit, otherwise the settings of resistor R will shift the operating point of the transistor. The

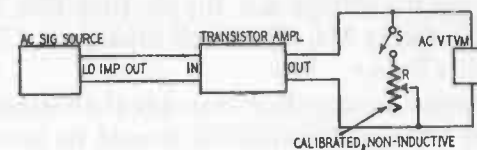

Fig. 911. Circuit for measurement of output impedance.

output impedance should be measured at various values of transistor d.c. electrode currents and, in the case of an amplifier, at various values of generator impedance.

Frequency response

Important transistor characteristics which vary with frequency are current amplification, voltage amplification, input impedance, and output impedance. Some other characteristics, such as electrode capacitances and inductances, r_m , and other resistances also show frequency dependence, but usually the first-mentioned characteristics are the ones checked in routine appraisals of transistor performance. Current amplification and voltage amplification are of particular interest, since the cutoff frequencies of these characteristics determine to a great extent the highest frequencies at which transistor amplifiers and oscillators can be operated.

Alpha vs. frequency

The d.c. measurement of alpha was discussed earlier. Current amplification may be expressed also as the ratio of an output alternating current change to the small change in the input alternating current which produces it. The test-signal frequency may be varied over a suitable range to show variation of current ampli-

fication with frequency. Fig. 912-a shows a test circuit for checking alpha in this manner.

The transistor is biased in the normal manner. The constant-current d.c. supply furnishes emitter bias, read with milliammeter

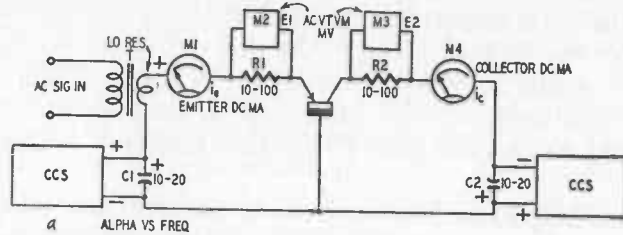

Fig. 912-a. Test circuit for checking alpha.

M1, and the constant-voltage d.c. supply furnishes collector bias read with milliammeter M4. The large capacitors, C1 and C2, bypass these supplies for a.c.

The a.c. test signal is supplied through the secondary of transformer T. The test-signal amplitude should be between 0.1 and 0.5 volt r.m.s. across the secondary. A single transformer will not handle both audio and radio frequencies, and care must be taken when interchanging transformers and signal generators to keep

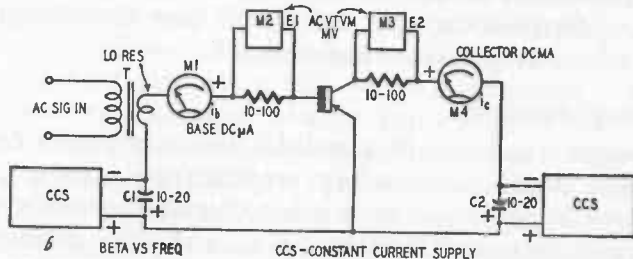

Fig. 912-b. Test circuit for checking base-to-collector current amplification.

the secondary impedance and d.c. resistance as nearly constant as possible.

The a.c. emitter current develops a voltage drop across the small series resistor R1. This drop is read as E1 with the first a.c. vacuum-tube voltmeter-millivoltmeter M2. Similarly, the a.c. collector current develops a voltage drop, E2, across R2, and this voltage is read with the second such meter, M3. Greatest convenience will be supplied by two separate meters. In cases of economy, however, a switching arrangement may be used to switch a single meter between emitter and collector circuits. Alpha is the ratio of E2 to E1.

When making a run of alpha vs. frequency, voltage E1 must be maintained at a constant value. The output waveform should be monitored with an oscilloscope, to guard against overloading of the transistor.

Beta vs. frequency

Fig. 912-b shows a test circuit for checking base-to-collector current amplification (beta) against frequency. This circuit is seen to be similar to the alpha tester of Fig. 912-a except for the grounded-emitter connection of the transistor, reversal of polarity

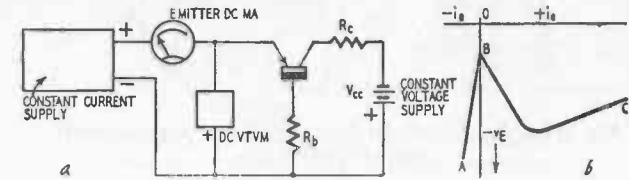

Fig. 913-a, -b. Circuit for testing emitter negative-resistance characteristics.

of the constant-current d.c. supply and of capacitor C1, and substitution of a d.c. microammeter M1. The test procedure is the same as described for alpha vs. frequency.

Voltage gain vs. frequency

The test circuits shown in Fig. 909 can be employed to check voltage gain as a function of frequency. The frequency of the input signal is varied throughout the desired test band while maintaining constant the signal-voltage amplitude.

A single transformer, T, cannot handle both audio and radio frequencies. When interchanging transformers and signal generators, however, care must be taken to keep the impedance and d.c. resistance of the transformer secondaries as nearly constant as possible. R2 is changed to rated R_L value.

Impedance vs. frequency

Input and output impedance, as a function of frequency, can be checked with the circuits given in Figs. 910 and 911 by varying the test-signal frequency over the desired range. The test signal-voltage and generator output impedance should be held constant. At each test frequency, the impedance should be checked in the manner described earlier.

Switching characteristics

The emitter and collector negative-resistance characteristics which suit point-contact transistors to switching-type circuits may

be checked with the test circuits shown in Figs. 913 and 914, respectively. The values of R_b , R_c , and R_e , V_{cc} , and V_{ee} must be selected for the particular type of transistor under test.

Emitter negative resistance

In the test setup shown in Fig. 913-a, follow this procedure: (1) Reverse the polarities of the constant-current emitter d.c. supply

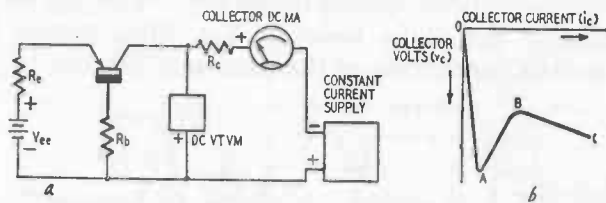

Fig. 914-a, -b. Circuit for testing collector negative-resistance characteristics.

and of the milliammeter temporarily. (2) Increase the emitter current in selected steps by adjusting the output of the constant-current supply. (3) Plot the corresponding values of negative emitter voltage to obtain the AB portion of the characteristic curve (Fig. 913-b). (4) Open the emitter connection temporarily to obtain the voltage reading at zero current. (5) Restore the connection and also the original polarity of the constant-current supply and milliammeter. (6) Increase the emitter current in steps and plot the corresponding emitter voltage points to obtain the remainder of the curve between B and C.

Collector negative resistance

Using the test circuit shown in Fig. 914-a, vary the collector current in selected steps by adjustment of the output of the constant-current supply. Plot the corresponding collector voltage points to obtain the characteristic curve OABC, as shown in Fig. 914-b.

Switching time

Fig. 915 shows test circuits for measurement of rise time and fall (cutoff) time of a switching transistor. A pulse generator and fast (wide-band, high-frequency-swept) oscilloscope are required for these tests. The output pulse of the monostable rise-time test circuit (Fig. 915-a) is initiated by the input trigger pulse but is independent of the waveform of the latter. The buildup of the output pulse thus indicates the transistor rise time.

In the cutoff-time test circuit (Fig. 915-b), the rectangular input pulse has a period t of 10 microseconds. The cutoff (fall time) of

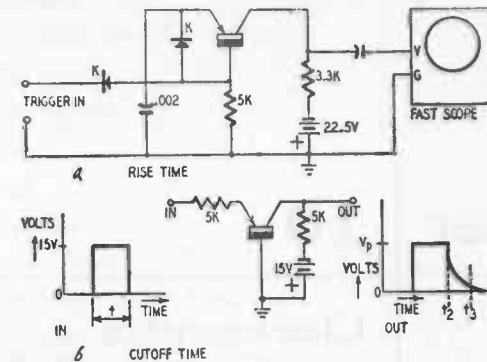

Fig. 915-a, -b. Test circuits for measurement of rise and fall time of a switching transistor.

the output pulse is equal to $t_3 - t_2$ measured between V_p and $0.1 V_p$. There are many schemes for checking rise and fall times. In general, however, the final criterion will be the switching performance of the transistor in the actual circuit in which it is to be used.

RECOMMENDED READING

1. *Methods and Equipment for Transistor Testing*. B. J. O'Neill and Arthur Gutterman. *ELECTRONICS*, July 1953. p. 172.
2. *Testing Transistors*. K. Lehovec. *ELECTRONICS*, June 1949. p. 88.
3. *Measurement of the Small Signal Parameters of Transistors*. Geoffrey Knight Jr., Richard A. Johnson, and Roland B. Holt. *PROCEEDINGS OF THE I.R.E.*, August 1953. p. 983.
4. *Transistor Measurements with the Vacuum-Tube Bridge*. *GENERAL RADIO EXPERIMENTER*, March 1953. General Radio Company; Cambridge, Massachusetts.
5. *Obtaining Transistor Characteristic Curves*. Warren Philbrook. *RADIO & TELEVISION NEWS*, September 1953. p. 66.
6. *Test Technique for Transistors*. Rufus P. Turner. *RADIO-ELECTRONICS*, March 1953. p. 78.
7. *Transistor Characteristics at Low and Medium Frequencies*. L. J. Giacoletto. *TELE-TECH*, March 1953. p. 97.
8. *Transistors in Terms of Vacuum Tubes*. Hans E. Hollmann. *TELE-TECH*, May 1953. p. 74.
9. *Oscilloscopic Display of Transistor Static Electrical Characteristics*. N. Golden and R. Nielsen. *PROCEEDINGS OF THE I.R.E.*, November 1952. p. 1437.

Chapter 10

Characteristics of Commercial Transistors

THE data presented in this chapter have been taken from manufacturers' published ratings, with their permission. All of these characteristics are tentative, since improvements steadily are being made in commercial transistors. Where blanks appear in the Tables, the data in question could not be obtained. The entire field has been solicited. Any manufacturer not appearing in this listing and who was offering transistors at the time of this writing, was omitted by that manufacturer's specific request.

In order to list in the most useful manner the numerous ratings, three sets of Tables have been prepared and appear in the following order: *Absolute Maximum Ratings, All Types; Typical Amplifier Operation, Junction and Point-Contact; and Typical Operation, Point-Contact Switches.*

In each table, listings are made alphabetically by the names of manufacturers.

Abbreviations Used in the Tables

- a alpha. (current amplification factor)
- CURR. AMP. Current amplification factor.
- db decibels
- F_c cutoff frequency
- G-B Grounded-base
- G-C grounded-collector
- G-E grounded-emitter

- i_c collector current
- i_e emitter current
- inv. v_e emitter peak inverse voltage
- k times 1000
- ma d.c. milliamperes
- mc megacycles
- mw milliwatts
- μ sec microseconds
- N-P-N junction type N-P-N
- NF noise factor or noise figure
- P-C point-contact
- P_c maximum collector dissipation
- PG power gain
- P-N-P junction type P-N-P
- PO power output
- R_i input resistance or impedance
- R_L load resistance or impedance
- R_o output resistance or impedance
- temp temperature
- v volts
- v_c collector voltage
- v_e emitter voltage

FOOTNOTES FOR TABLES ON FOLLOWING PAGES

- a. At 25°C. ambient
- b. At 30°C. ambient
- c. Alpha loss = 3db from 1 kc value
- d. Junction temperature 30°C., $f = 1$ kc., source imp. 100 ohms
- e. Design center
- f. Junction temperature 75°C., $f = 1$ kc., source imp. 100 ohms
- g. Junction temperature 30°C., $f = 1$ kc., source imp. 600 ohms
- h. Junction temperature 75°C., $f = 1$ kc., source imp. 600 ohms
- i. Junction temperature 30°C., $f = 1$ kc., source imp. 30K ohms
- j. Junction temperature 30°C., $f = 1$ kc., source imp. 7,500 ohms
- k. Alpha loss = 3 db from 270-cycle value
- l. Junction temperature 30°C., $f = 1$ kc., source imp. 15K ohms
- m. Frequency at which alpha = 1
- n. At 1,000 cycles
- o. Generator impedance 50 ohms
- p. Generator impedance 60 ohms, $f = 1$ kc.
- q. Generator impedance 600 ohms, $f = 1$ kc.
- r. Load impedance 5K ohms. High source impedance
- s. Generator impedance 0.22 megohm, $f = 1$ kc.
- t. At $i_e = 0.5$ ma, $v_c = -15$ v.
- u. At $i_e = 2$ ma, $v_c = -15$ v.
- v. At $i_e = 0.5$ ma, $v_c = -7$ v.

ABSOLUTE MAXIMUM RATINGS, ALL TYPES

MANUFACTURER	Type No.	Class	V _c (volts)	i _c (ma)	P _c (mw)	V _e (volts)	i _e (ma)	inv. V _e (volts)	temp. (°C.)	Out-line
CBS-Hytron	PT-2A	P-C	-40	-10	100			-40	55	1
	PT-2S	P-C	-40	-10	100			-40	55	1
	2N36	P-N-P	-20	-8	50				50	2
	2N37	P-N-P	-20	-8	50				50	2
	2N38	P-N-P	-20	-8	50				50	2
General Electric	G11	P-C	-30	-7	100			-50	40	3
	G11A	P-C	-30	-7	100			-50	40	3
	2N43	P-N-P	-45	-10	150*				100	4
	2N44	P-N-P	-45	-10	150*				100	4
	2N45	P-N-P	-45	-10	150*				100	4
Hydro-Aire	A-O	P-C	-20		50	-10			100	5
	A-1	P-C	-20		50	-10			100	5
	A-2	P-C	-20		50	-10			100	5
	A-3	P-C	-20		50	-10			100	5
	S-1	P-C	-50		60	-30			100	5
S-2	P-C	-35		60	-30			100	5	
National Union	T18A	P-C	-50	-20	120*	5		-50		6
	T18B	P-C	-50	-20	120*	5		-50		6
	2N39	P-N-P	-30	-5	50*					7
	2N40	P-N-P	-30	-5	50*					7
	2N42	P-N-P	-30	-5	50*					7
Radio Receptor	RR14	P-N-P	-25	-5	50				50	8,9
	RR20	P-N-P	-25	-5	50				50	8,9
	RR21	P-N-P	-25	-5	50				50	8,9
	RR34	P-N-P	-20	-5	30				50	8,9
	R1698	P-C	-40		120					
	R1734	P-C	-40		120					
	R1729	P-C	-30							

} See switching data under Typical Operation
1.0

ABSOLUTE MAXIMUM RATINGS, ALL TYPES

MANUFACTURER	Type No.	Class	V _c (volts)	i _c (ma)	P _c (mw)	V _e (volts)	i _e (ma)	inv. V _e (volts)	temp. (°C.)	Out-line
Raytheon	CK716	P-C	-40	-4	100					10
	CK721	P-N-P	-20	-5	30*				50	11
	CK722	P-N-P	-20	-5	30*				50	11
RCA	2N32	P-C	-40	-8	50			-40	40	12
	2N33	P-C	-8.5	-7	30				40	12
	2N34	P-N-P	-25	-8	50				50	13
	2N35	N-P-N	25	8	50				50	13
Sylvania	2N32	P-C	-40	-8	50				40	14
	2N34	P-N-P	-25	-8	50				50	14
Texas Instruments	102	P-C	-40	-15	75*			-40	50	15
	103	P-C	-40	-15	75*			-40	50	15
	200	N-P-N	30	5	50*				50	15
201	N-P-N	30	5	50*				50	15	
Transistor Products	2A	P-C	-50	-8	120			-50	50	16
	2B	P-C	-50	-8	120			-50	50	16
	2C	P-C	-50	-8	100			-50	50	16
	2D	P-C	-50	-8	100			-50	50	16
	2E	P-C	-50	-8	100			-50	50	16
	2F	P-C	-100	-40	120			-50	50	16
	2G	P-C	-100	-40	120			-50	50	16
	X-22	N-P-N	40	5	50				49	17
	X-23	N-P-N	40	5	50				49	17
Westinghouse	WX-3347	P-C			100				60	18
	WX-4813	P-N-P			200				60	19

TYPICAL AMPLIFIER OPERATION JUNCTION AND POINT-CONTACT

MANUFAC-TURER	Type No.	Class	Cir-cuit	V_c (volts)	i_c (ma)	i_e (ma)	R_1 (ohms)	R_o or R_L (ohms)	Curr. Amp.	PG (db)	PO (mw)	NF (db)	F_c (mc)
CBS-Hystron	PT-2A	P-C	G-B	-30	1.0	300	20k	1.5	1.5	19	57	57	2c
General Electric	G11	P-C	G-B	-25	0.5	475	20k	2.2	17	57	57	2c	
				-5	1.0	60	50k	0.98e	28				
				-20	5	10	4k	0.98e	39				
	2N43	P-N-P	G-Eg	-5	1.0	1k	30k	0.98e	40	40	40	1k	
				-20	5	300	4k	0.98e	15				
				-5	1.0	30k	600	0.98e	28				
	2N44	P-N-P	G-Bd	-5	1.0	55	50k	0.955e	40	40	40	40	1k
				-20	5	10	4k	0.955e	38				
				-5	1.0	700	30k	0.955e	12				
	2N45	P-N-P	G-Eh	-5	1.0	15k	600	0.955e	28	28	36	40	40
				-20	5	10	4k	0.92e	36				
				-5	1.0	300	30k	0.92e	11				
Hydro-Aire	A-0	P-C	G-B	-8	0.3	550	20k	3.0	3.0	50	25n	25n	4.5m
				-8	0.3	550	20k	2.0	3m				
				-8	0.3	400	16k	2.0	1.5m				
	A-2	P-C	G-B	-8	0.3	400	16k	2.0	2.0	50	25n	25n	0.5m
				-8	0.3	400	16k	2.0	5c				
				-8	0.3	400	16k	2.0	5c				
	T18A	P-C	G-B	-15	0.75	300	15k	20	20	36	22n	22n	22n
				-4.5	1.0	500	30k	>0.94	38				
				-4.5	1.0	500	30k	>0.90	36				
	2N40	P-N-P	G-E	-4.5	1.0	500	30k	>0.85	32	30	20	5	
				-4.5	1.0	500	30k	>0.85	32				
				-4.5	1.0	500	30k	>0.85	32				
2N42	P-N-P	G-E	-4.5	1.0	500	30k	>0.85	32	30	20	5		
			-4.5	1.0	500	30k	>0.85	32					
			-4.5	1.0	500	30k	>0.85	32					
RR14	P-N-P	G-E	-1.5	0.5	30k	30k	2.5	2.5	65n	22	22	0.1	
			-1.5	0.5	30k	30k	2.5	0.1					
			-1.5	0.5	30k	30k	2.5	0.1					
RR20	P-N-P	G-E	-1.5	0.5	30k	30k	2.5	2.5	65n	22	22	0.1	
			-1.5	0.5	30k	30k	2.5	0.1					
			-1.5	0.5	30k	30k	2.5	0.1					
RR34	P-N-P	G-E	-1.5	0.5	30k	30k	2.5	2.5	65n	22	22	0.1	
			-1.5	0.5	30k	30k	2.5	0.1					
			-1.5	0.5	30k	30k	2.5	0.1					
RI729	P-C	G-B	-30	1.0	190	6k	2.5	2.5	65n	22	22	0.1	
			-15	1.0	150-450	10k-40k	1.5	29					
			-6	2	70	100k	0.975	29					
Raytheon	CK716	P-C	G-B	-15	1.0	150-450	10k-40k	1.5	1.5	29	65n	22	0.1
	CK721	P-N-P	G-B	-6	2	70	100k	0.975	0.975	29	65n	22	0.1

TYPICAL AMPLIFIER OPERATION JUNCTION AND POINT-CONTACT

MANUFAC-TURER	Type No.	Class	Cir-cuit	V_c (volts)	i_c (ma)	i_e (ma)	R_1 (ohms)	R_o or R_L (ohms)	Curr. amp.	PG (db)	PO (mw)	NF (db)	F_c (mc)
Raytheon	CK721	P-N-P	G-E	-1.5	0.5	1k	20k	0.90	0.90	36	2.8	22	22
				-3	2	650	20k	0.975	38	22			
				-6	2	300k	20k	0.975	12	22			
	CK722	P-N-P	G-E	-6	2	50	100k	0.90	0.90	29°	30	34	34
				-1.5	0.5	1k	20k	0.90	30	34			
				-6	2.0	325	20k	0.90	34	34			
RCA	2N33	P-C	G-B	-8	0.3	special oscillator up to 50 mc	See Figure 507, chapter 5.	0.98	40	40	40	40	
Texas Instruments	200	N-P-N	G-B	5	1	60	100k	0.90	0.90	29p	34q	30p	40q
				5	1	500	20k	0.95	40q	12*	20		
				5	1	500	20k	0.95	20				
Transistor Products	2A	P-C	G-B	-40	0			0.90	0.90	20	20	20	20
				-4	3			0.95	20	20	20		
				-3	1			0.95	20	20	20		
2B	P-C	G-B	-40	0			0.95	0.95	20	20	20	20	
			-4	3			0.95	20	20	20			
			-3	1			0.95	20	20	20			
2D	P-C	G-B	-15	0			0.90	0.90	20	20	20	20	
			-2	3			0.95	20	20	20			
			-1	0			0.95	20	20	20			
2E	P-C	G-B	-15	0			0.90	0.90	20	20	20	20	
			-2	3			0.95	20	20	20			
			-4	0			0.95	20	20	20			
X-22	N-P-N	G-B	-4.5	1	35	100k	0.90	0.90	20	20	20	20	
			-4.5	1	35	500k	0.95	20	20	20			
			-4.5	1	35	500k	0.95	20	20	20			
Westing-house	WX-3347	P-C	G-B	-22.5	2 to 3	0.3-0.8	400	10k	2	18	18	2	
	WX-4813	P-N-P	G-E	-6	1 to 2		400	10k	2	30	30	2	

TYPICAL OPERATION, POINT-CONTACT SWITCHES

MANUFACTURER	Type No.	Off Collector Current (ma)	On Collector Voltage (volts)	Rise Time (μsec.)	Turnoff Time (μsec.)	Curr. Amp. _a	F _c mc
CBS-Hytron	PT-2S	-1.5 (i _e =0 ma., v _c =-30v.)	-4 (i _e =3 ma., i _c =-5 ma.)		1	2 (i _e =0.05 ma., v _c =-30v.)	
	G11A	-0.8 (i _e =0, v _c =-15v.)	-2 (i _e =3 ma., i _c =-4 ma.)			2.5 (i _e =.05 ma., v _c =-15v.)	3t
Hydro-Aire	S-1			<0.5	<2		
	S-2			<1	<6		
National Union	T18B	-1 (i _e =0.1 ma., v _c =-35v.)	-2 (i _e =1 ma., i _c =-2 ma.)		1	1.7 on 0.15 off	
	Radio Receptor						
Radio Receptor	R1698	-2.2 (i _e =0, v _c =-40v.)	-4 (i _e =3 ma., i _c =-5.5 ma.)				1.5
	R1734	-0.7 (i _e =0, v _c =-7v.)	-1.2 (i _e =3 ma., i _c =-4 ma.)				10
Texas Instruments	102	-1.5 (i _e =0, v _c =-30v.)	-1.8 (i _e =1 ma., i _c =-2 ma.)	<0.2	<2		
	103	-1.5 (i _e =0, v _c =-30v.)	-1.8 (i _e =1 ma., i _c =-2 ma.)		>2		
Transistor Products	2C	0 to -1 ma. (i _e =0, v _c =-15v.)	0 to -2 (i _e =3 ma., i _c =-4 ma.)			2	2v
	2F	0 to 0.7 (i _e =0, v _c =-15v.)	0 to -1.2 (i _e =3 ma., i _c =-4 ma.)			2	5v
	2G	0 to 0.7 (i _e =0, v _c =-15v.)	0 to -1.2 (i _e =3 ma., i _c =-4 ma.)			2	10v

In these outlines, E = emitter; C = collector; B = base. All dimensions are in inches. All illustrations twice actual size.

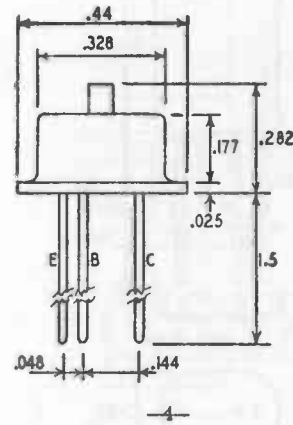
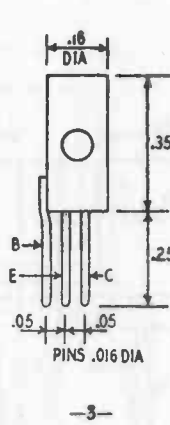
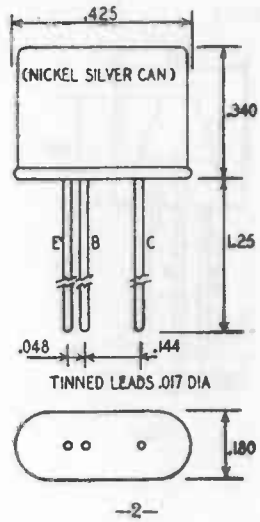
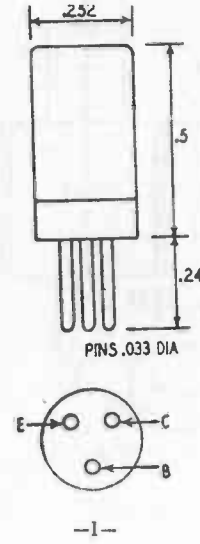

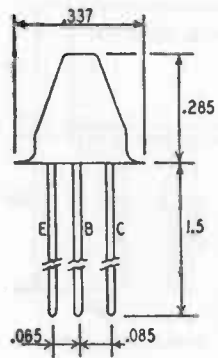

-5-

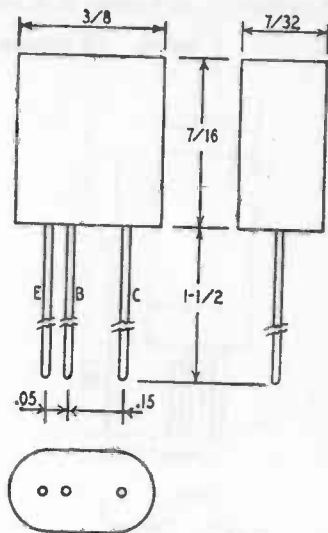

-6-

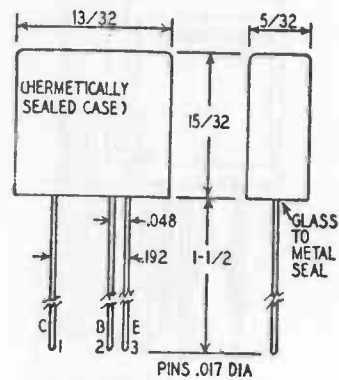

-9-

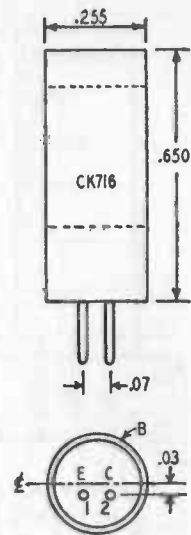

-10-

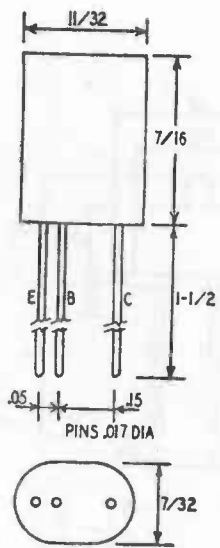

-7-

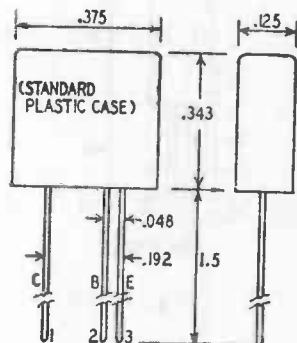

-8-

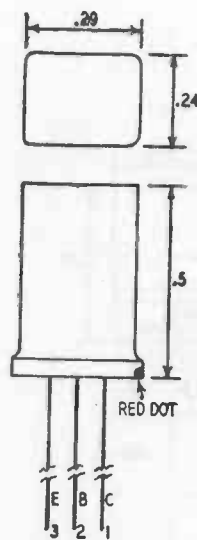

-11-

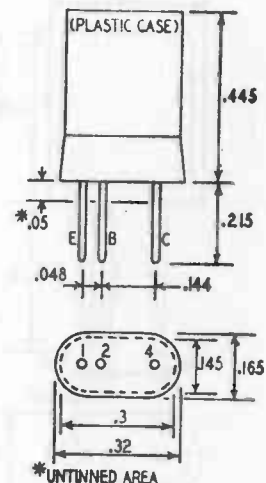

-12-

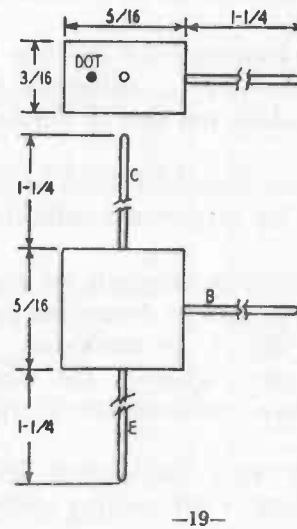
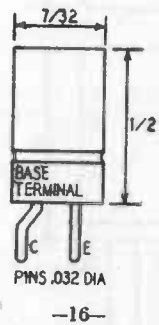
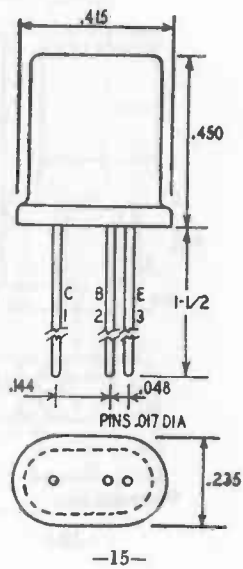
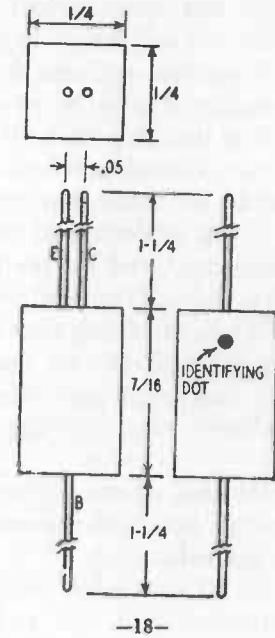
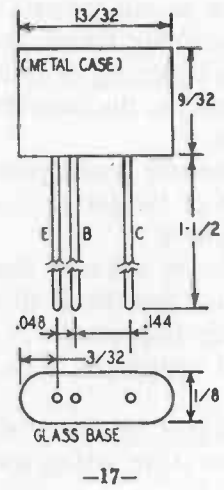
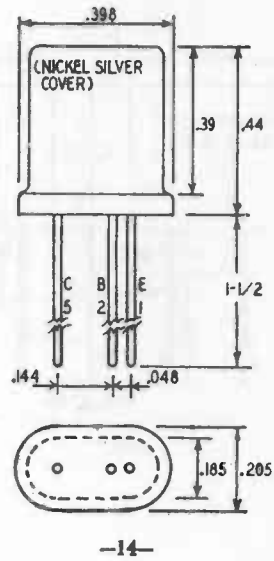
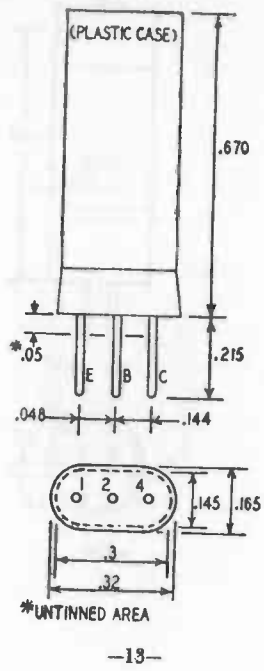

CARE AND HANDLING OF TRANSISTORS

1. Do not operate close to hot tubes and components.
2. Do not subject to large transients which momentarily may exceed transistor ratings. A circuit which is satisfactory in all other respects should be examined for switching transients.
3. It is best to switch-off power before inserting or removing a transistor. However, when this is not feasible, the base connection should be made first and broken last.
4. When soldering or welding to transistor leads, provide a satisfactory heat sink on the transistor side of the joint. A simple method is to hold the lead with flat-nose pliers.
5. When checking new transistor circuits, advance the electrode voltages slowly to their final values. Switching them on suddenly may introduce harmful switching transients.
6. Check carefully the polarities of transistor d. c. bias supplies.
7. Do not operate transistors at ambient or internal temperatures in excess of the maximum temperature rating specified by the manufacturer
8. In all operation and tests, be careful not to exceed the maximum collector and emitter dissipation values specified by the transistor manufacturer.
9. Do not operate or store in a damp atmosphere unless the transistor is of the hermetically-sealed or evacuated type.
10. Use constant-current supplies to furnish the d. c. biases to a transistor.
11. Before installing a transistor for the first time, check its current amplification factor and i_{co} (collector current at zero emitter current). Check i_{co} drift not due to ambient temperature changes.
12. While transistors have excellent shock and vibration characteristics, they should not be subjected needlessly to mechanical abuse.
13. Do not operate in strong magnetic or electrostatic fields without first making suitable tests to determine the effect of such fields upon behavior and life of the transistor.
14. Before installing, check class of the transistor: that is, whether point-contact N-type, point-contact P-type, N-P-N junction, or P-N-P junction.
15. Before potting with other components, ascertain from the transistor manufacturer whether the potting temperature will be injurious.
16. Transistors in transparent or translucent capsules are apt to be light-sensitive. Shield them from strong illumination.

Index...

Acceptor	8	Backward Power Gain	45
Acceptor Impurity	8	Bandwidth, Grounded-Emitter	60
Active Mutual Characteristic	42	Barrier Layer	23
Active Resistance Network	41	Barrier, Potential	14
Adjustable-Output D. C. Power		Base:	
Supply	110	Current	29, 34
A. F. Amplifiers, Transformer-		Floating	50
Coupled	90	Resistance	30, 50
Alpha	25, 27, 28, 32, 34, 42, 83, 117	Resistor, Adjustment of	91
Alpha Cutoff	38, 39, 59, 74	-To-Collector Amplification	32, 33
Alpha vs. Frequency	121	-Tuned Circuit	66
Aluminum	7	Voltage	34
Ambient	39	Basic Audio Oscillator	95
Amorphous Solids	5	Beta	32, 33, 117, 118
Amplification:		Beta Measurement	117
Base-To-Collector	32, 33	Beta vs. Frequency	123
Bilateral	45	Bias:	
Current	63, 117	Collector	25, 26
D. C.	52	Emitter	25, 26
Factor, Current	25, 42, 83	Polarity	27
Power	44	Supplies	49, 110
Reverse Power	45	Supplies, Constant-Current	51, 110
Voltage	63, 118	Supply, Dual	49
Amplifier:		Supply, Single	49
Characteristics	63, 130, 131	Bilateral Amplification	45
D. C.	58	Binary Counter	87
Formulas	63	Bistable Characteristic	34
Frequency Response, Audio	90	Bistable Switching Circuit	84
Grounded-Base	43, 47	Bonds, Valence	6
Grounded-Collector	44, 47	Boosting Audio Power Output	93
Grounded-Emitter	43, 47	Boron	7, 21
Impedance-Coupled, Single-Tuned	80	Broadcast-Band R. F. Amplifier	100
Shunt-Fed	61	Broadcast Receivers	101
Stages, Shielding in	100	Burnout Point	15
Type D. C. Microammeter	104	Cadmium Sulphide	6
Amplifiers:		Capacitance-Coupled Output	67
Audio	89, 90	Capacitive Coupling	51
Multistage	54	Capacitively-Coupled, High-	
Push-Pull for Speaker Operation	93	Impedance Output	72
R. F.	59	Capacitors, Coupling	54
Atom, Donor-Impurity	9	Carborundum	6
Audio Amplifier:		Care of Transistors	138
Frequency Response	90	Carrier Injection	24
Grounded-Base	89, 90	Carriers	10, 14, 15
Grounded-Collector	89, 90	Cascading	53
Grounded-Emitter	89, 90	Catwhisker	13, 19
Power Gain	90, 92	Characteristics:	
Resistance-Coupled	91, 92	Active Mutual	42
Transformer-Coupled	90, 92	Amplifier	63, 130, 131
Audio Oscillator	95	Bistable	34
Audio Oscillator, Basic	95	Collector Output	57
Audio Oscillator, Light-Powered	96	Conduction	8
Audio Power Output, Boosting	95	Curves	30, 31, 111
Audio Signal Injector	97		

Curves, Measurements for	111
Feedback	32, 113
Forward	114
Input	112
Matching	54
Of Commercial Transistors	126
Output	112
Point-Contact Switches	132
Static Collector D.C.	57
Switching	124
Transfer	32
Choke-Coil Coupling	62
Circuits, Dual	77
Circuits, Equivalent	41
Class-A Efficiency	37
Class-B Efficiency	37
Class-B Operation	55
Class-B, Push-Pull	55
Code-Practice Oscillator	96
Coefficient, Negative Temperature	10
Collector	18
Collector:	
Bias	25, 26
Current	29, 30, 31, 32, 51
Current, No-Signal	91
Current Ratings	39
Current vs. Collector Voltage	36
Dissipation	36
Negative Resistance	124
Output Characteristics	57
Resistance	79
Voltage	29, 51
Voltage vs. Collector Current	36
Voltage Ratings	39
Commercial Transistors,	
Characteristics of	126
Complementary Symmetry	55, 59
Components, Resistive	30
Conduction Characteristics	8
Configurations, Transistor	28, 29
Constant-Current D. C.	
Supplies	51, 110
Constant-Current Parameter	31
Constant-Current Requirements	50
Control, Gain	56
Control Pulse	82
Control, Regeneration	102
Control Signal	82
Control, Volume	56
Copper Oxide	6
Copper Sulphide	6
Counter, Binary	87
Coupling:	
Capacitive	51
Capacitors	54
Choke Coil	62
Direct	51
Impedance	62
Inductive	69, 72
Input-Output	51
Transformer	51
Crystal:	
Controlled Standard	73
Diode Tuner	101
Faces	5
Oscillator	72
-Type Frequency Standard	99
Crystals	5
Crystals, Germanium	12
Crystals, Quartz	72
Current:	
Amplification	63, 117
Amplification Factor	25, 42, 83
Base	29, 34
Collector	29, 30, 31, 32, 51
Diode Forward	15
Electrode	51
Emitter	80, 84
Forward	15
Gain, Direct Measurement of	117
Ratings, Collector	39
Ratings, Emitter	39
Reverse	15
Stabilizing Resistor	62
vs. Voltage Relationships	33
Curves, Characteristic	30, 31, 111
Curves Measurements for	
Characteristic	111
Cutoff	33, 59, 83
Cutoff:	
Alpha	38, 39, 59, 74
Frequency	38
Time Test Circuit	125
Voltage-Gain	59
Db Noise Figures	37, 38
Db Power Gain	47
D.C.:	
Amplification	52
Bias Supply, Constant-Current	110
Power Supply, Adjustable Output	110
Relay	104
Requirements of Transistors	39
Supplies, Constant-Current	110
Design, Duality in	76
Detector, Diode	102
Detector, Plate	79
Diffused Junction	13
Diffused-Type Transistor	20
Diode:	
Detector	102
Forward Current	15
Junction	14
Resistance	15, 24
Reverse Current	15
Tuner	101
Diodes	14
Direct-Coupled Amplifier	58
Direct Coupling	51
Dissipation:	
Collector	36
Emitter Power	36, 37
Line, D. C.	57, 58
Power	36, 37
Donor	8
Donor Impurity	8
Donor-Impurity Atom	9
Double-Tuned Amplifier	62, 63
Drift, Electron	10
Drift, Hole	10
Dual Bias Supply	49
Dual Circuits	77, 79
Dual, Value of	78
Duality	76
Duals	78
Efficiency	37
Efficiency, Class-A	37
Efficiency, Class-B	37
Electrode Current	51
Electrode External Resistances	45
Electrode, Reference	109
Electron Drift	10
Electron Movement	8
Electron Orbit	7
Electrons and Holes	6
Electrons, Injection of	15
Electrons, Valence	6
Emitter	18
Emitter:	
Bias	25, 26
Current	30, 34
Current Ratings	39
Negative Resistance	124
Power Dissipation	36, 37

-To-Base Voltage	29
-To-Collector Amplification	
Factor	32
Voltage	29, 34
Equivalent Circuits	41
Equivalent Noise Circuit	46
External Resistances, Electrode	45
Feedback	65, 67, 68, 69
Feedback:	
Characteristics	32, 113
Inductive	67
Inductively-Coupled,	
Series-Resonant	69
Loop	68
Negative	57
Network	72
Over-All	57
Output-to-Input	50
Positive	50
Series-Resonant	68
Tickler	67
Voltage	57
Voltage, Positive	70
Field-Strength Meter	103
Flip-Flop	84
Floating-Base Input	50
Formulas, Amplifier	63
Forward Characteristics	114
Forward Current	15
Forward Transfer Resistance	42
Four Stage R-C Audio Amplifier	92
Frequency:	
Cutoff	38
Limits	38
Limits, Oscillator	73
Meter, Heterodyne	105
of Oscillation	68, 69, 70, 74
Range of Junction Transistor	59, 60
Response	38, 121
Response, Audio Amplifier	90
Standard, Crystal-Type	99
Standards	99
vs. Alpha	121
vs. Beta	123
vs. Impedance	123
vs. Voltage Gain	123
Gain:	
Audio Amplifier Power	90, 92
Control	56
Control, Position of	56
Current	117
Db Power	47
Power	25, 37, 47, 63
Voltage	25, 118
Reverse Power	45
Gallium	7, 21
Germanium	6, 11
Germanium Crystals	12
Germanium Wafers	12
Grounded-Base Amplifier	43, 47
Grounded-Base Audio Amplifier	89, 90
Grounded-Base Circuit	28, 29
Grounded-Collector Amplifier	44, 47
Grounded-Collector Audio	
Amplifier	90
Grounded-Collector Circuit	28, 29
Grounded-Emitter Amplifier	43, 47
Grounded-Emitter Audio	
Amplifier	89, 90
Grounded-Emitter Circuit	28, 29
Grounded-Emitter, Output	
Characteristic of	115
Grown Junction	13
Grown-Type Transistor	20
Handling Transistors	138
Hearing Aids	94, 95
Heating	10
Heterodyne Frequency Meter	105
High-Frequency Oscillation	66, 73, 74
High-Impedance Output	67, 69
High-Impedance Output,	
Capacitively-Coupled	72
Hole and Electron Injection	15
Hole Drift	7
Hole Movement	8, 10
Hole-Rich Semiconductors	7
Holes	6, 7
Holes and Electrons	6
Holes, Injection of	15
Impedance:	
Coupled Amplifier, Single-Tuned	80
Coupling	62
Input	50, 60, 63, 90, 119
Matching	61, 69, 92
Mismatch	53
Output	52, 60, 63, 120
Ratio, Interstage	60
Signal-Source	51
vs. Frequency	123
Impurities	8
Impurity, Acceptor	8
Impurity, Donor	8
Indium	13, 21, 23
Inductive Coupling	69, 72
Inductive Feedback	67
Inductively-Coupled Series-	
Resonant Feedback	69
Injection of Electrons	15
Injection of Holes	15
Input:	
Characteristics	112
Floating-Base	50
Impedance	50, 60, 63, 90, 119
Output Coupling	51
Resistance	30, 42, 47, 51, 116
Signal	25
Instability	34, 50
Instability, Short Circuit	35
Interstage Impedance Ratio	60
Intrinsic Semiconductors	8
Junction Diode	14
Junction-Type Transistors	18
Lattice	5, 7
Lead Sulphide	6
Life of Transistor	39
Light-Powered Audio Oscillator	96
Load Line	57, 58
Loading	69
Loading, Oscillator	100
Loop, Feedback	68
Loss, Power	53
Low-Power Operation	51
Matching Characteristics	54
Matching, Impedance	61, 69
Maximum Ambient	39
Maximum Power Dissipation	36
Measurement, Beta	117
Measurements	109
Measurements for Characteristic	
Curves	111
Measurements, Static	116
Meter, Field-Strength	103

Meter, Heterodyne-Frequency	105
Microammeter, Amplifier-Type D. C.	104
Microphone-Case Preamplifier	91
Mismatch, Impedance	53
Modulation	17
Monitor, Phone	102
Monostable Circuit-Single Shot	86
Multiple Bias Supply	49
Multistage Amplifiers	64
Multivibrator	97
Musical Toy	98
Mw Power Output	47
N-Type	7
National Bureau of Standards	
Oscillator	73
Negative:	
Feedback	57
Resistance	33, 34, 65, 83, 84
Resistance, Collector	124
Resistance, Emitter	124
Temperature Coefficient	10
Network Parameters	42
Network, Three-Terminal	30
Networks	30
No-Signal Collector Current	91
Noise	37
Noise:	
Circuit, Equivalent	46
Figures, Db	37, 38
Level	62
Noncrystalline Solids	5
One-Shot Circuit	86
Operation, Low-Power	51
Orbit, Electron	7
Oscillation, Frequency of	68, 69, 70
Oscillator:	
Audio	95
Basic Audio	95
Code-Practice	96
Crystal	72
Drift, Standard Frequency	73
Frequency	68, 74
Frequency Limits	73
High-Frequency	66, 73, 74
Light-Powered Audio	96
Loading	100
National Bureau of Standards	73
Phase-Shift	71, 72
Self-Excited	99
Stability	72
Synchronization	71
Tuning	74
Upper Frequency Limit	73
Oscillators	65
Oscillators, R-C Type	70
Oscillators, Standard-Frequency	73
Outlines	133, 134, 135, 136, 137
Oscillation, High-Frequency	66
Output:	
Capacitance-Coupled	67
Characteristic of Grounded-Emitter	115
Characteristics	112
High-Impedance	67, 69
High-Impedance, Capacitively-Coupled	72
Impedance	52, 60, 63, 120
Mw Power	47
Power	36, 37, 92
Pulse	70
Resistance	30, 42, 47, 116
Signal	25
Sine-Wave	70
-To-Input Feedback	57
Over-All Feedback	57
P-Type	7
Parameters	29, 31
Parameters:	
Constant-Current	31
Input	47
Network	42
Output	47
Resistive	29
Parallel-Resonant Tuned Circuits	62
Phase	57, 68
Phase:	
Reversal	47
Reversing Transformer	80
Shift	65
Shift Network	72
Shift Oscillator	71, 72
Phasing	72
Phone Monitor	102
Plate Detector	79
P-N Hook Theory	28
P-N Junction, Semiconductor Diode	12
Point-Contact Transistors	18
Polarity	34
Polarity, Bias	27
Position of Gain Control	56
Positive Feedback	50
Positive Feedback Voltage	70
Positive Resistance	84
Positive Resistance Regions	33
Potential Barrier	14
Power:	
Amplification	44
Amplification, Reverse	45
Dissipation	36, 37
Dissipation, Collector	30
Dissipation, Emitter	30, 37
Dissipation, Maximum	36
Gain	25, 37, 47, 63
Gain, Audio Amplifier	90, 92
Gain, Db	47
Gain, Reverse	45
Gain, R. F.	60
Loss	53
Output	36, 37, 47, 92
Output, Boosting Audio	93
Sensitivity	82
Signal	37
Supply, Adjustable Output D. C.	110
Supply Requirements	50, 51
Practical Transistor Circuits	89
Preamplifier, Microphone Case	91
Pulse:	
Action	86
Control	82
Generator	70
Output	70
Signal	82
Push-Pull	54, 55
Push-Pull Amplifier for Speaker	
Operation	93
Quartz	5
Quartz Crystals	72
Range, frequency	60
Ratings of Transistors	128, 129
Resistance-Coupled A. F. Amplifiers	92
Resistance-Coupled Oscillator	70
Receivers, Broadcast	101
Rectifiers	14

Reference Electrode	109
Regeneration Control	102
Relay	104
Resistance:	
Base	30
Collector	79
Coupled A. F. Amplifier	91, 92
Input	30, 42, 47, 51, 116
Negative	33, 34, 65, 83, 84
Network, Active	41
Of Transformer Windings	68
Output	30, 42, 47, 116
Positive	84
Regions, Positive	33
Static	29
Transformation	78, 79
Transistors, Determination of	116
Resistive Components	30
Resistive Parameters	29
Resistor, Base	50
Response, Frequency	38, 121
Reverse Current	15
Reverse Power Amplification	45
Reverse Power Gain	45
Reverse Transfer Resistance	42
R.F. Amplifier, Broadcast-Band	100
R.F. Amplifier, Single-Stage	100
R.F. Amplifiers	59
R.F. Power Gain	60
Saturation	33, 84
Secondary Frequency Standard	99
Selenium	6
Self-Excited Oscillator	99
Semiconductors	6, 8
Semiconductors:	
Hole-Rich	7
Intrinsic	8
Theory of	5
Diode Volt-Ampere Characteristic Curve	15
Sensitivity, Power	82
Series-Resonant Feedback	68
Series-Resonant Feedback, Inductively Coupled	69
Shielding in Amplifier Stages	100
Shock Hazard	111
Short-Circuit Instability	35
Shunt-Fed Amplifier	61
Signal:	
Control	82
Injector, Audio	97
Input	25
Output	25
Power	37
Pulse	82
Source Impedance	51
Trigger	82
Silicon	6, 11
Silicon Carbide	6
Sine-Wave Output	70
Single Bias Supply	49
Single-Shot Circuit	86
Single Stage R. F. Amplifier	100
Single-Stage Transformer-Coupled A. F. Amplifiers	90
Single-Stage Transformer-Coupled R. F. Amplifiers	61
Single-Tuned Impedance-Coupled Amplifier	80
Solids, Amorphous	5
Solids, Noncrystalline	5
Spreading	10
Stability, Oscillator	72
Stabilizing Resistor	62

Standard Frequency Oscillator	73
Standard-Frequency Oscillator Drift	73
Standards, Frequency	99
Static Collector D. C.	
Characteristics	57
Static Measurements	116
Static Resistance	29
Static Volt-Ampere Characteristic Curve	15
Surface-Barrier Transistor	22
Switches	82
Switching:	
Action	83
Characteristics	124
Circuit	106
Circuit, Bistable	84
Time	124
Type Transistors	35
Symmetry, Complementary	55, 59
Synchronization, Oscillator	71
Temperature Effects	39
Test-Circuit Setups	111
Test-Signal Injector	97
Testing Transistors	109
Tests	109
Tetrode Transistor	39
Three-Stage Transformer-Coupled A. F. Amplifier	93
Three-Terminal Network	30, 43
Tickle Feedback	67
Time, Switching	124
Time, Transit	38
Total Resistance	45
Toy, Musical	98
Transfer Characteristics	32
Transfer Resistance, Forward	42
Transfer Resistance, Reverse	42
Transformer:	
Coupled, A. F. Amplifier, Three-Stage	93
Coupled, A. F. Amplifiers	90, 92, 93
Coupled, Grounded-Collector, A. F. Amplifier	91
Coupled, R. F. Amplifier, Single-Stage	61
Coupling	51
Feedback	67
Phase-Reversing	80
Turns Ratios	53
Winding Resistance	68
Transformation Resistance	79
Transistor:	
Action	24
Amplifiers	47
Characteristics	17
Configurations	28
Parameters	29
Types	17
Transistors, Care of	138
Transistors, Commercial	126
Transit Time	38
Trigger Signal	82
Triggers	82
Triode Transistors	17
Tuned Circuits, Parallel Resonant	62
Tuned Feedback Loop	68
Tuner, Diode	101
Tuning, Oscillator	74
Turns Ratio, Transformer	53
Valence Bonds	6
Valence Electrons	6

Volt-Ampere Characteristic Curve, Semiconductor Diode	15	Emitter-to-Base	29
Volt-Ampere Characteristic Curve, Static	15	Feedback	57
Voltage:		Gain	25, 118
Amplification	63	Gain Cutoff	59
Base	34	Gain vs. Frequency	123
Collector	29, 51	Ratings, Collector	39
Divider	49	vs. Current Relationships	31
Emitter	29, 34	Volume Control	66
		Wafers, Germanium	12

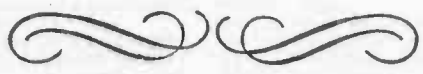

Be Sure to Read These Other GERNSBACK LIBRARY Books

42—**HIGH-FIDELITY TECHNIQUES.** A guide to hi-fi for those who want to get into audio. A handbook to help you get top performance from your equipment. If you like to work at high fidelity, try new systems, then this informative book is for you. 112 pages \$1.00

43—**MODEL CONTROL BY RADIO.** Remote control of model planes, boats, autos. Easy to understand and build. Completely covers theory and construction of coders, transmitting and receiving systems, detectors, power control circuits, servomotors, control systems. 112 pages. \$1.00

44—**BASIC RADIO COURSE.** 26 chapters on radio theory that are as easy to read as a novel. Describes the action of radio circuits in a quick-to-grasp manner. Starting with elementary concepts, the author discusses radio components and then blends them into an easily digestible circuit analysis. Supplies a wonderful electronic background. Illustrated. Durable hard cloth cover 176 pages. \$2.25

45—**RADIO TUBE FUNDAMENTALS.** The first low-priced book to give a complete understanding of radio tubes. Covers tubes from electron theory to a working analysis of the different types. 96 pages. \$1.00

46—**TÉLÉVISION TECHNQUES.** Authentic case histories of TV troubles based on TV repair information supplied by technicians and service departments of TV manufacturers. Expressly written for practicing TV service technicians. Television Technques describes and solves over 600 tough TV servicing problems. 128 pages. \$1.50

47—**RADIO & TV HINTS.** Contains hundreds of shortcuts taken from the experience of service technicians, radio amateurs, audio fans, experimenters, and engineers. The hints and kinks in this book are practical, are in actual use, and can be put to work by you. 112 pages. \$1.00

48—**HIGH FIDELITY.** A three-part book giving audio men the maximum amount of information on modern audio design, construction, and measurement techniques. Written by audio men this unusual volume contains a complete section on building audio amplifiers. 128 pages. \$1.50

49—**RADIO AND TV TEST INSTRUMENTS.** For technicians who like to build equipment. Gives

step-by-step details on the construction of model test units used in servicing radio and TV. Describes 22 test instruments, including instructions on how to build a Picture Tube Circuit Analyzer, Picture Tube Tester, Three-Inch Scope, Portable Sig Generator, Dynamic Signal Tracer, Practical V.I.V.M., TV Marker Generator, etc. 128 pages. \$1.50

50—**TV REPAIR TECHNIQUES.** Covers unusual TV troubles. Tells how to do signal tracing, service TV in the home, how to overcome high-voltage troubles, picture-tube circuit difficulties, how to service horizontal locks, cure TVI, intercarrier buzz, brightness troubles, etc. 128 pages. \$1.50

52—**THE OSCILLOSCOPE.** An easy-to-read book on how to get the most out of this test instrument. Includes chapters on waveforms; the cathode-ray tube, sweep systems, typical scopes, alignment techniques, tests, measurements, and experiments using the scope. 192 pages. \$2.25

53—**RADIO-CONTROL HANDBOOK.** A how-to-do-it book for all hobbyists interested in radio control for planes, boats, trucks, tractors, etc. Practical construction information, ideas and suggestions for every component of control systems. 192 pages. \$2.25

54—**PROBES.** Explains how probes are designed, constructed, and used. Describes crystal-demodulator probes, voltage-doubler probes, balanced; low capacitance; high-voltage; isolation and direct probes. Has full information on how to buy or build. Covers specialized probes, including a transistorized type. 224 pages. \$2.50

55—**SWEEP & MARKER GENERATORS** for Television and Radio. Completely describes the theory behind the construction of sweep and marker generators. Tells you what you can and cannot do with these generators, explains how to get the most out of them, how to use them properly. Thoroughly illustrated with actual waveforms. 224 pages. \$2.50

57—**THE V.T.V.M.** A completely practical book explaining how vacuum-tube voltmeters work and how to use them. Describes the circuits in the v.t.v.m. and how to service radio, FM, TV receivers and audio amplifiers with this test instrument. Contains a chapter on how to troubleshoot and repair your own v.t.v.m. Has many hints and suggestions on getting the v.t.v.m. to do special jobs for you. 224 pages. \$2.50